

FLARE See Through 45H

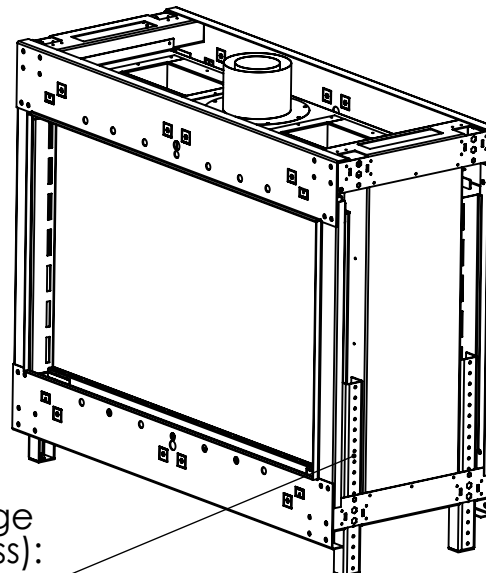

Telescopic Leg Range
(from bottom of glass):
9" - 19"

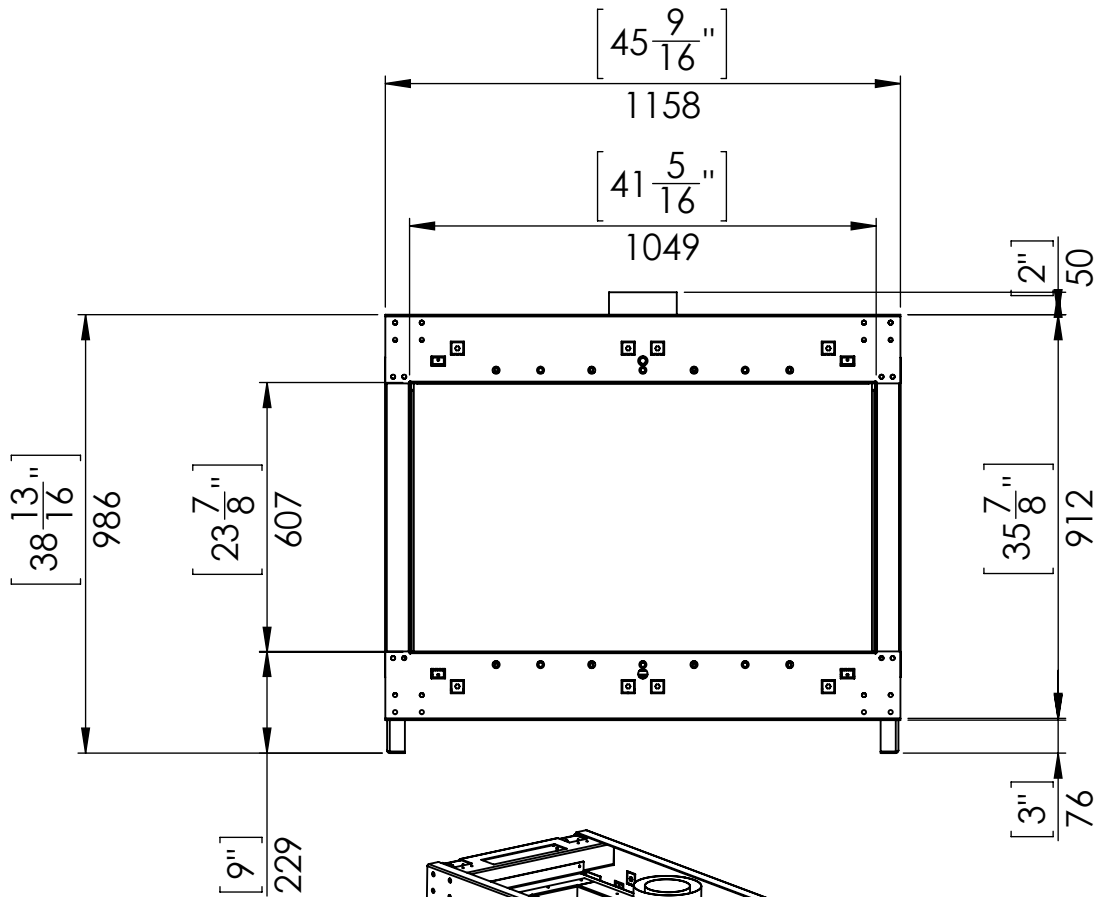
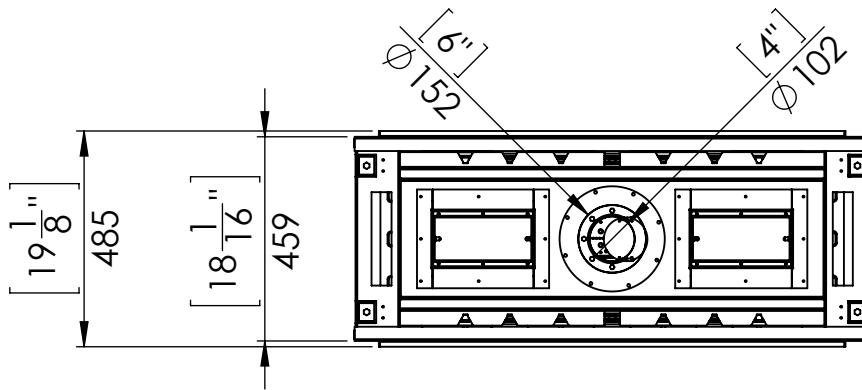
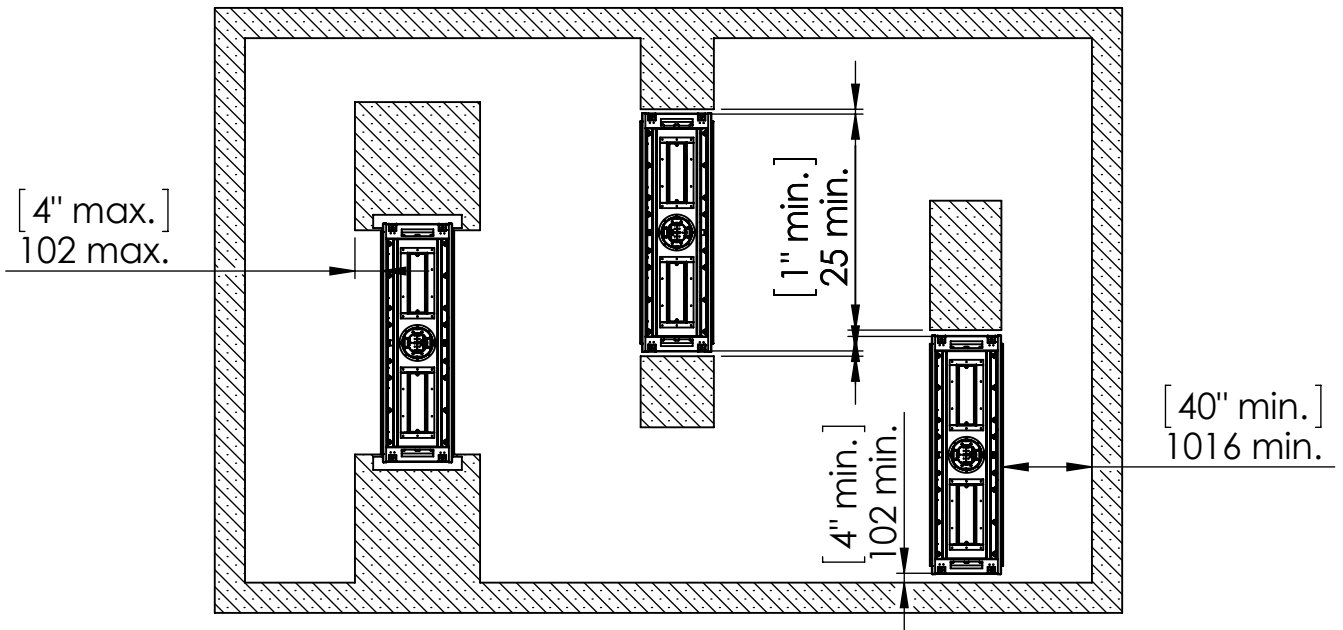

Chimney Installation

Horizontal Termination

For 4 x 6 vent size create 8" x 10" vent termination opening

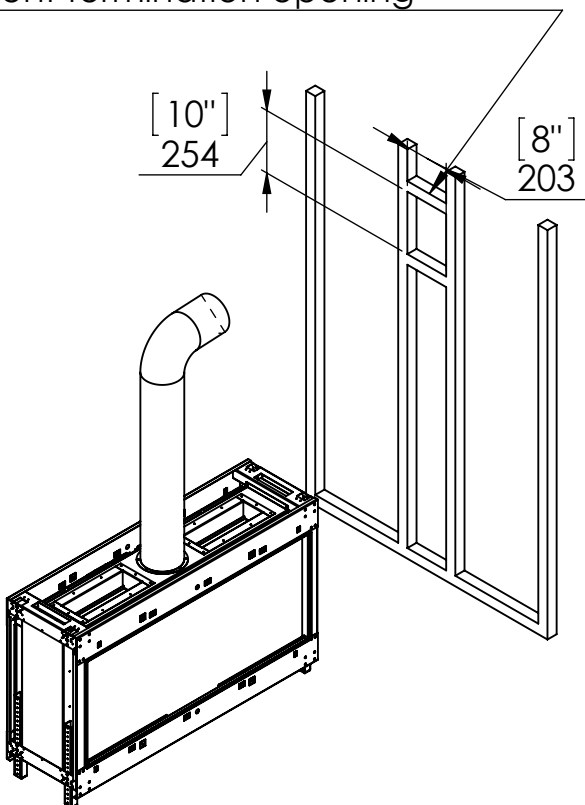

Vertical Termination

For 4 x 6 vent size create 8" x 8" vent termination opening

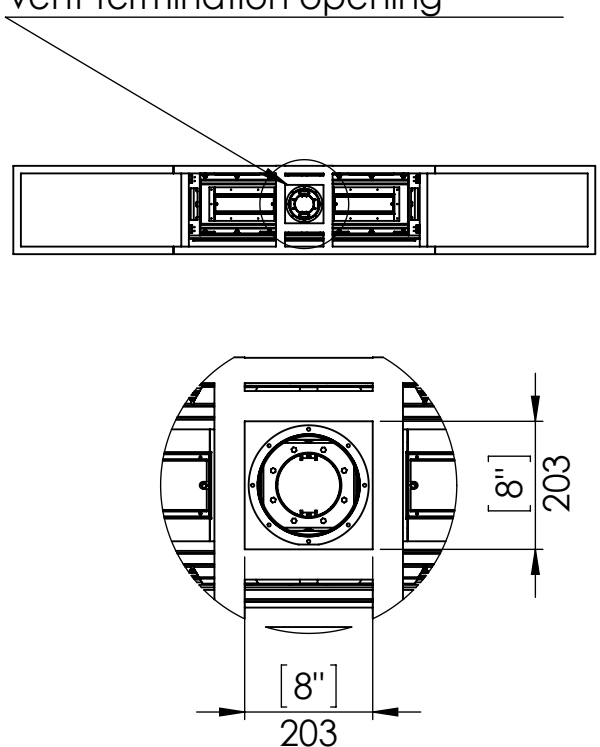

Flat Installation

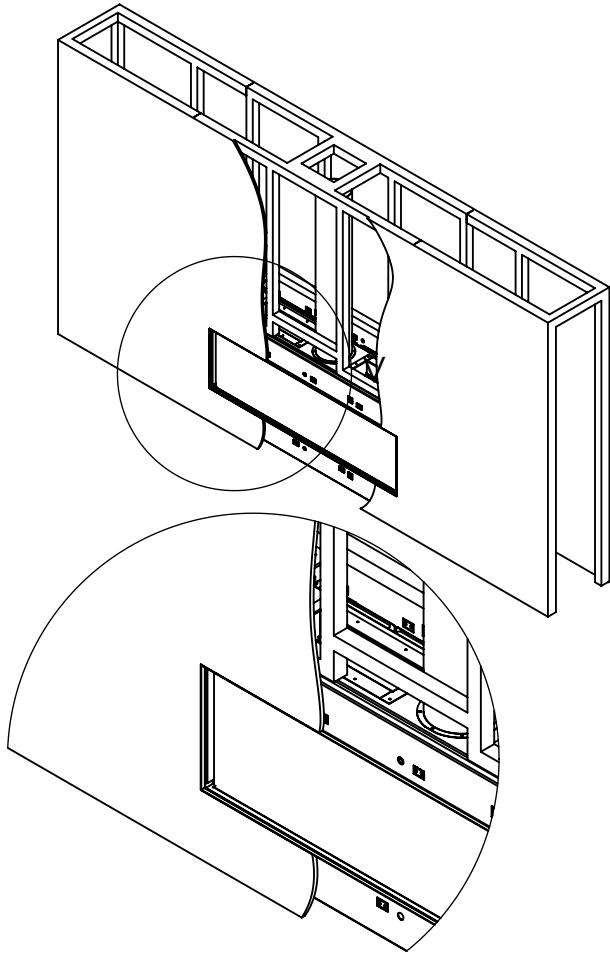

L Shape Installation

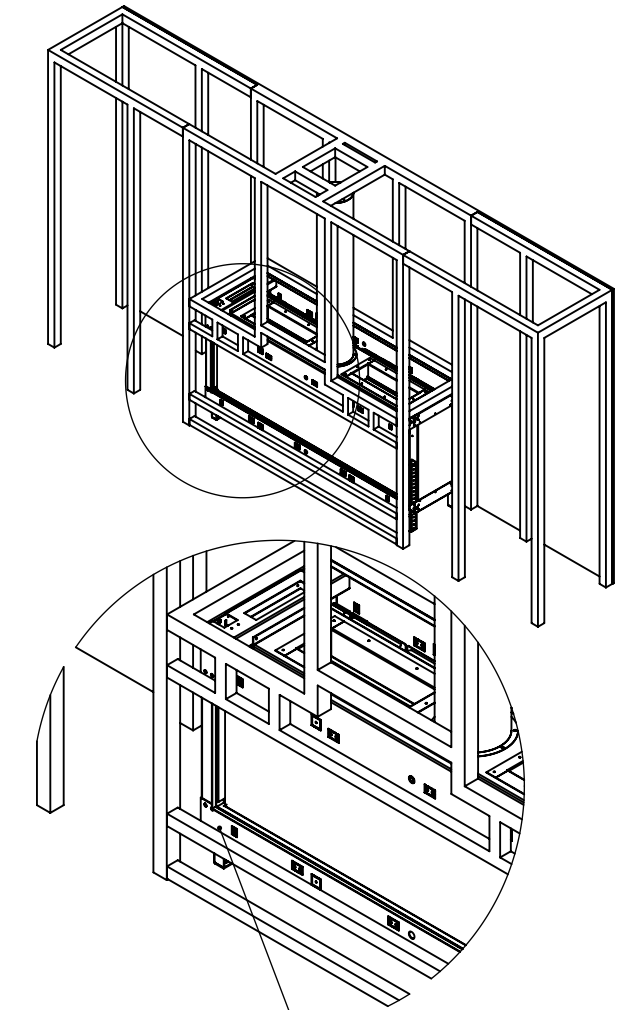

Max. Shelf Width

Step 1 - Basic Framing :

Step 1 - Basic Framing :

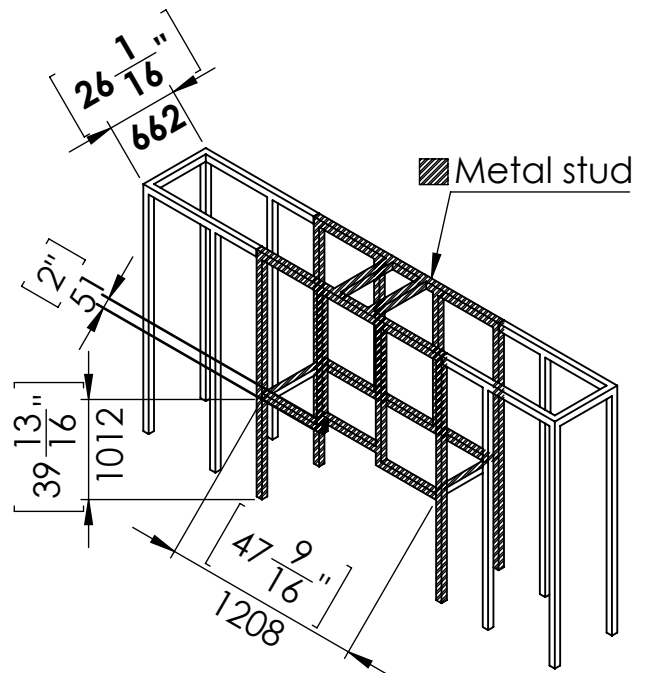
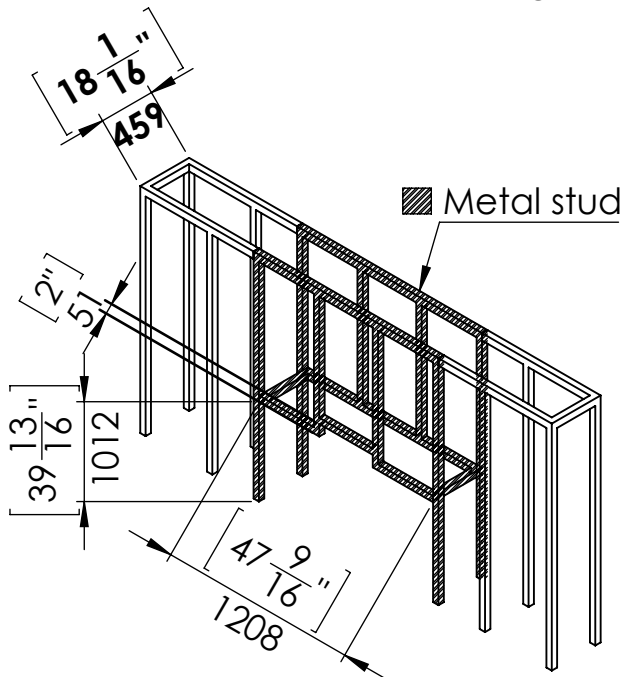

Flat Installation

Step 2 -Positioning the Fireplace:

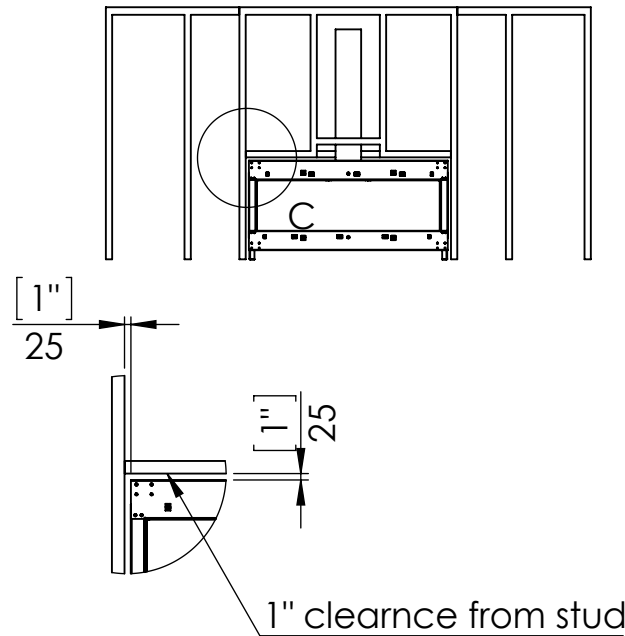
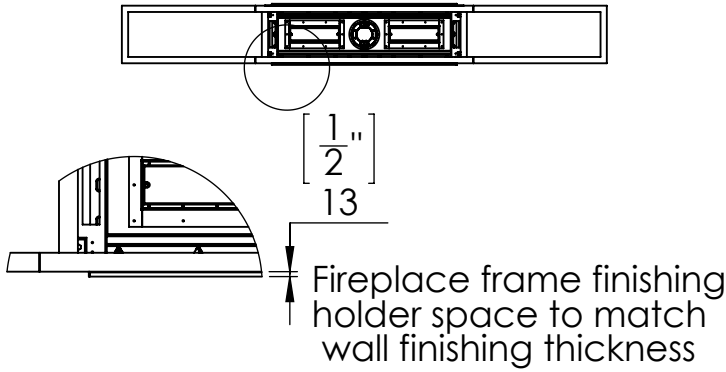

Last Step - Finishing The Fireplace Wall:

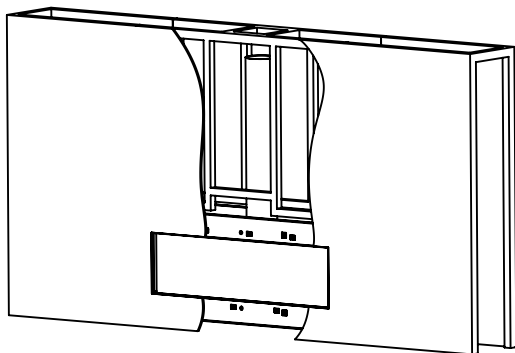

L Shape Installation

Step 2 -Positioning the Fireplace:

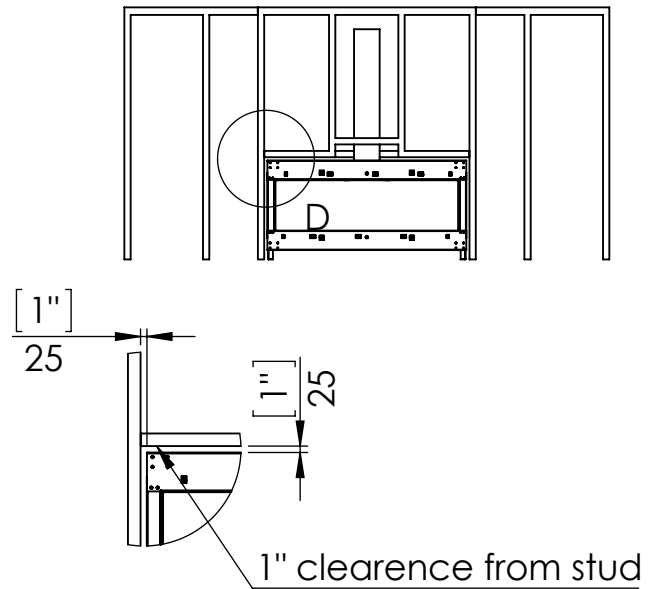
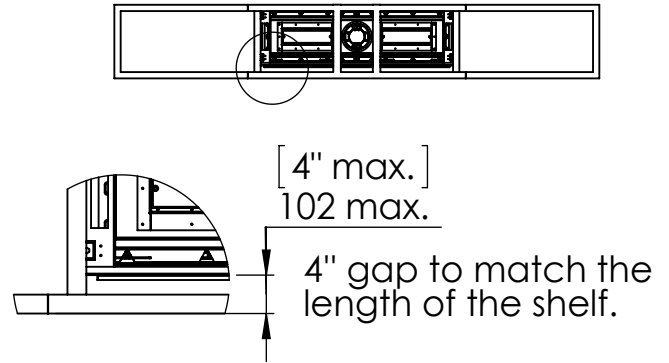

Step 3 - Framing Front Studs For L Shape:

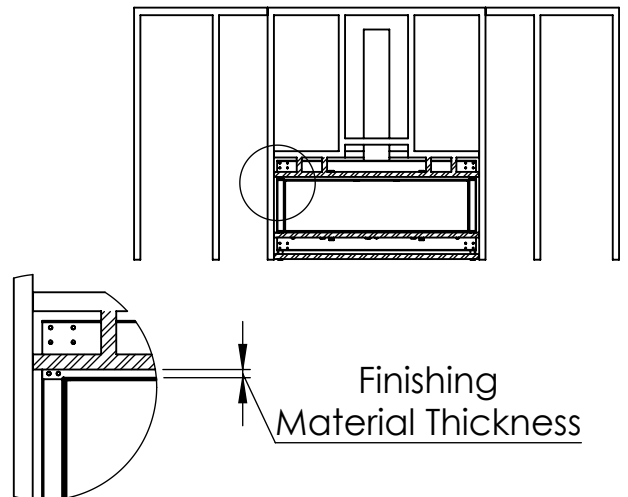

L Shape Finishing Install

Last Step - Finishing The Fireplace Wall:

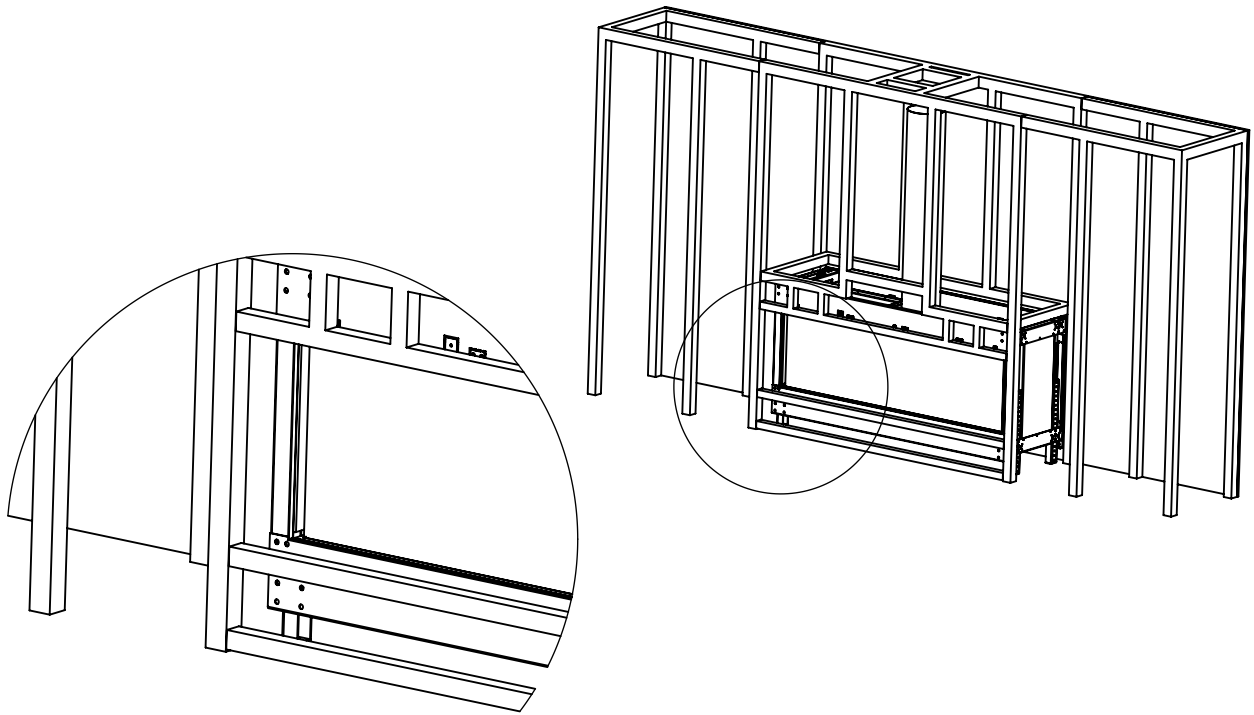

Specifications for Appliance Flare See Through 45H

Factor	NG	LPG
Burner Type	80	80
Orifice	1000	260
BTU Max.	36800	26300
BTU min.	22000	17750
Kw/h	10.8k	7.7k
Chimney DIA.	5X8	5X8
Manifold Pressure[w.c]	4.7	10.4
Efficiency rate	82	83
Glass Size Length\Width	1030 X 620 mm	40" 9/16 X 24" 9/16'
Appliance Weigh	110Kg	242lb