

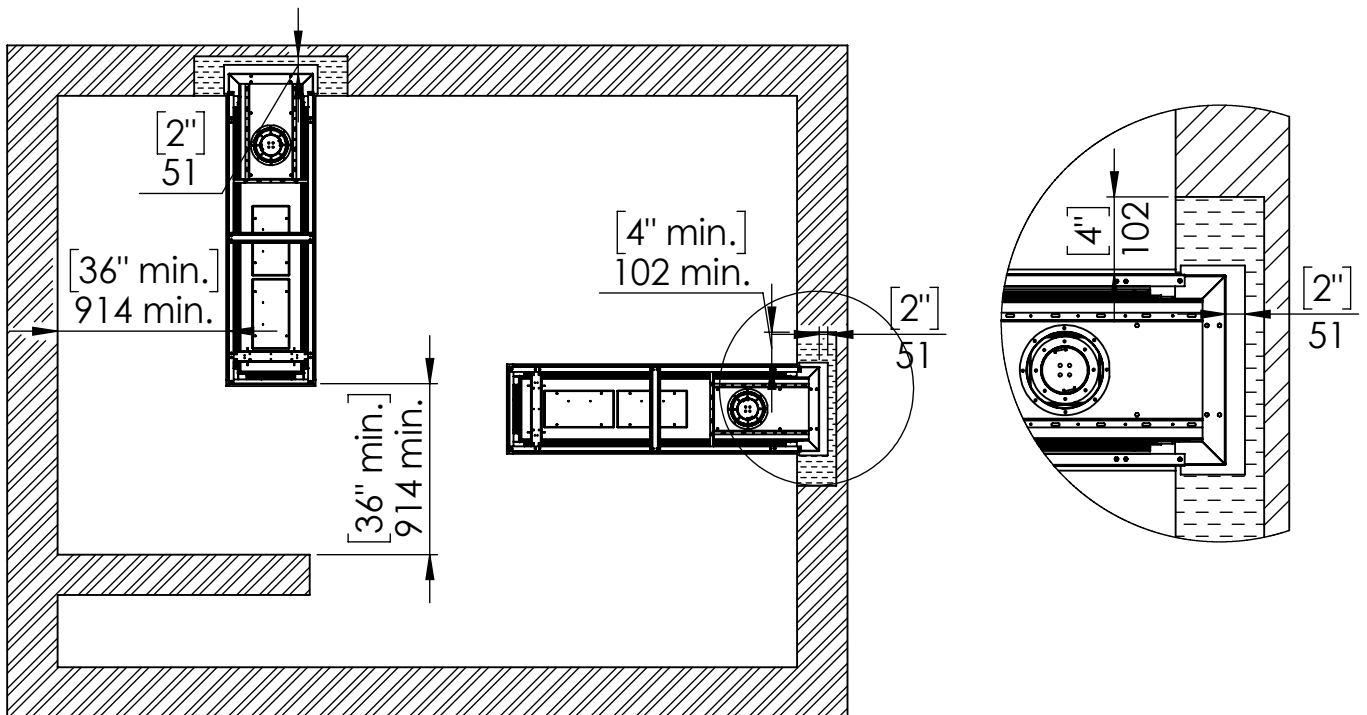

Specifications for Appliance Flare Room Definer 45

Factor	NG	LPG
Burner Type	80	80
Orifice	1000	260
BTU Max.	36800	26300
BTU min.	22000	17750
Kw/h	10.8k	7.7k
Chimney DIA.	5x8	5x8
Manifold Pressure[w.c]	4.7	10.4
Efficiency rate	78	82
Glass Size Length\Width	1030 X 420 mm	40" 9/16 X 16" 9/16'
Appliance Weigh	120Kg	265lb

Appliance Location



 Combustible Materials
 Non Combustible Materials



Flare Room Definer 45

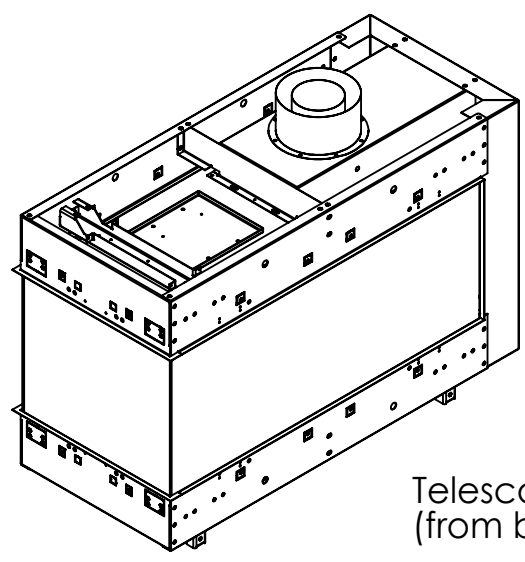
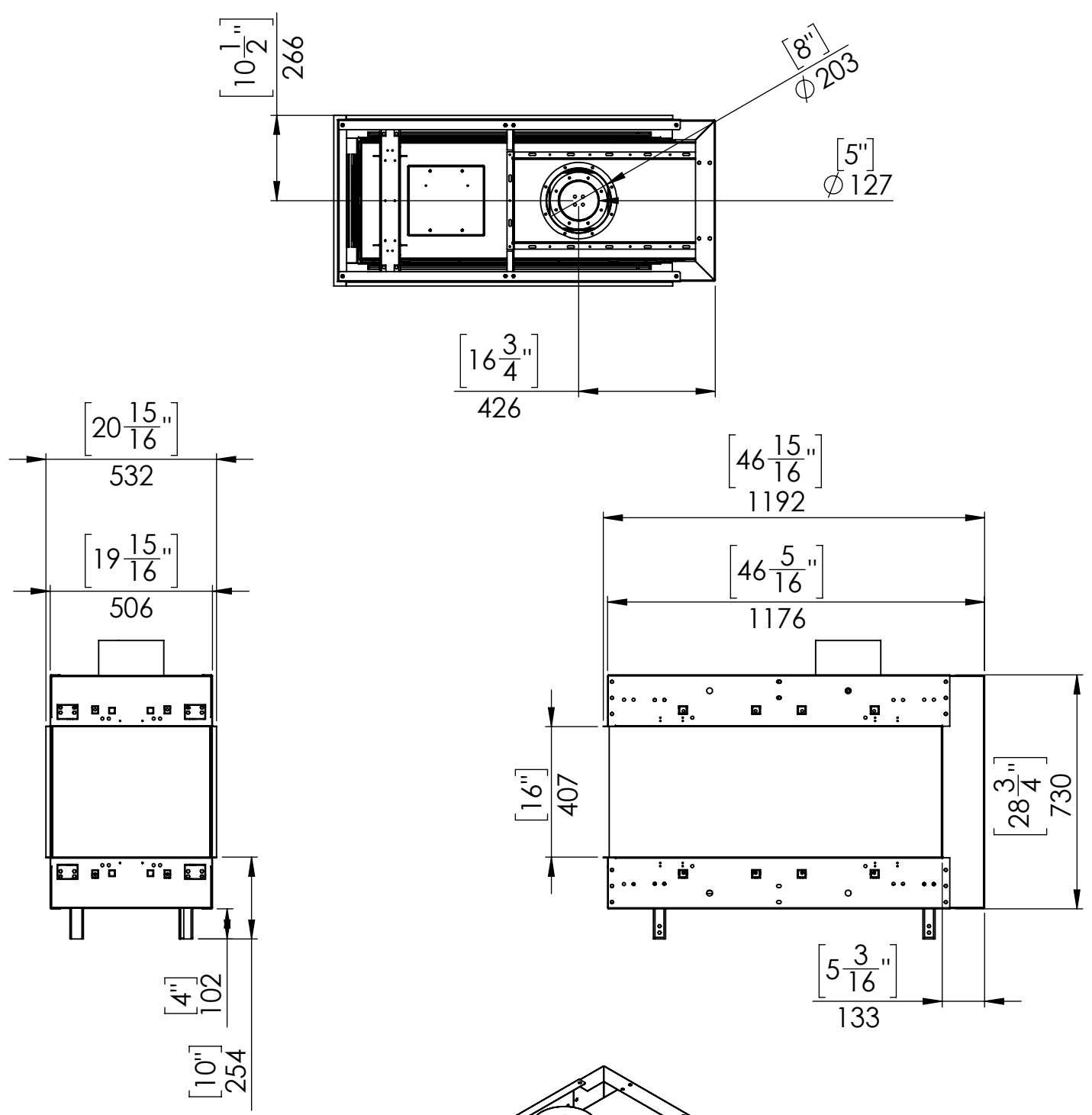

Telescopic leg ranges (from bottom of the glass): 10"-21"

Flat Installation

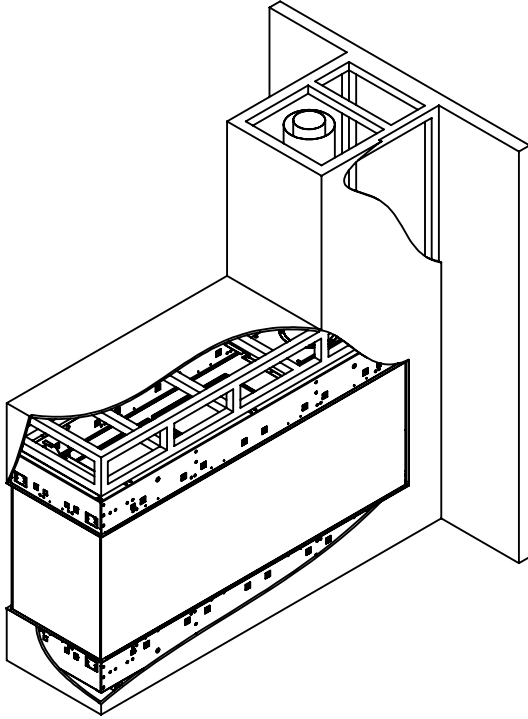

Step 1 - Basic Framing :

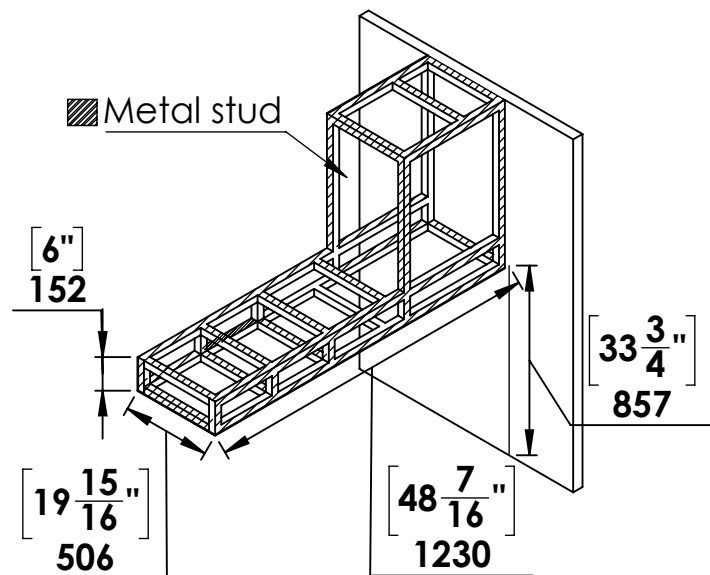

Recess Installation

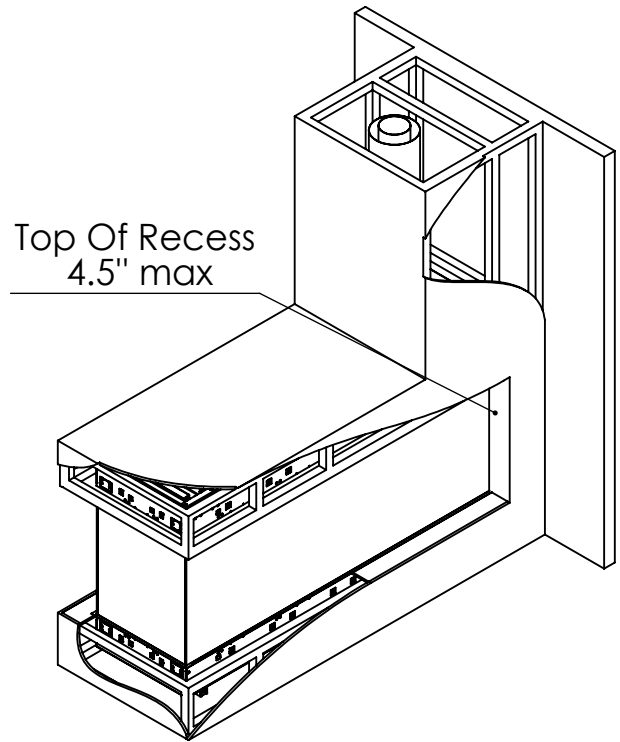

Step 1 - Basic Framing :

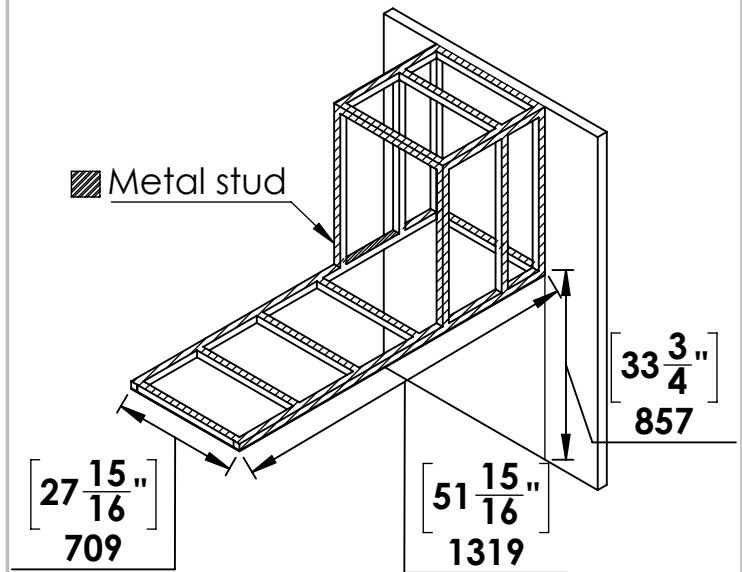

Flat Installation

Step 2 -Positioning the Fireplace:

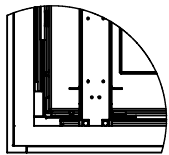
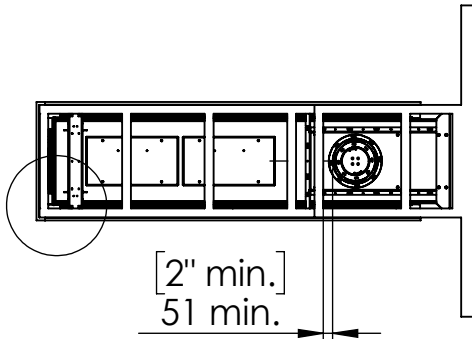

Fireplace frame finishing holder space to match wall finishing thickness

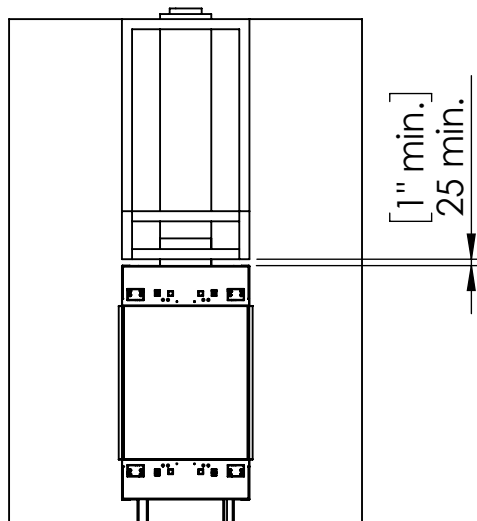

Recess Installation

Step 2 -Positioning the Fireplace:

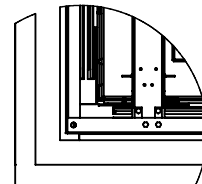
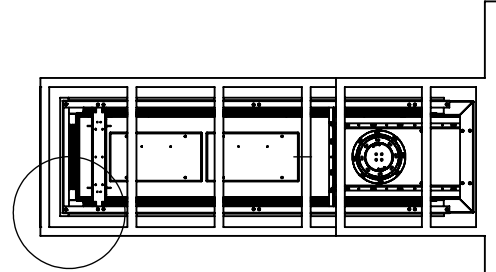

gap to match the max. length of top shelf.

[4" max.]
102 max.

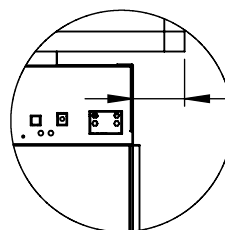
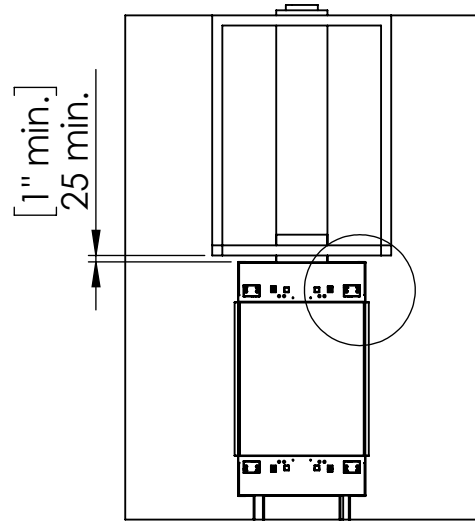

[4" max.]
102 max.

Flat Installation

Last Step - Finishing The Fireplace Wall:

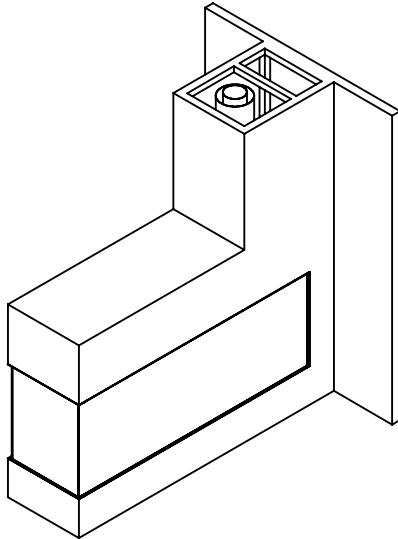

Recess Installation

Step 3 - Framing Front Studs For Recess
After positioning the Fireplace:

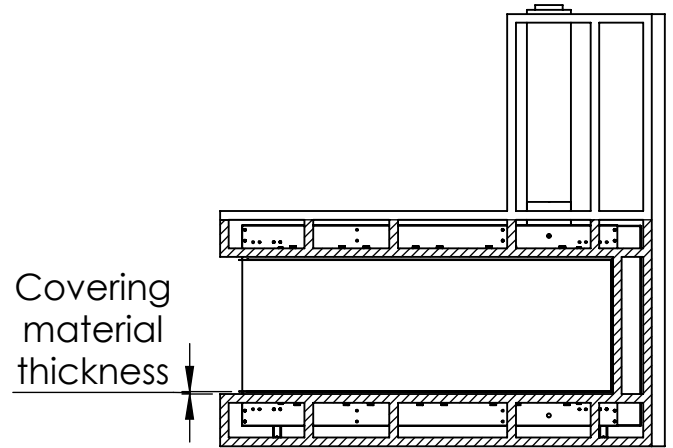

Last Step - Finishing The Fireplace Wall:

