

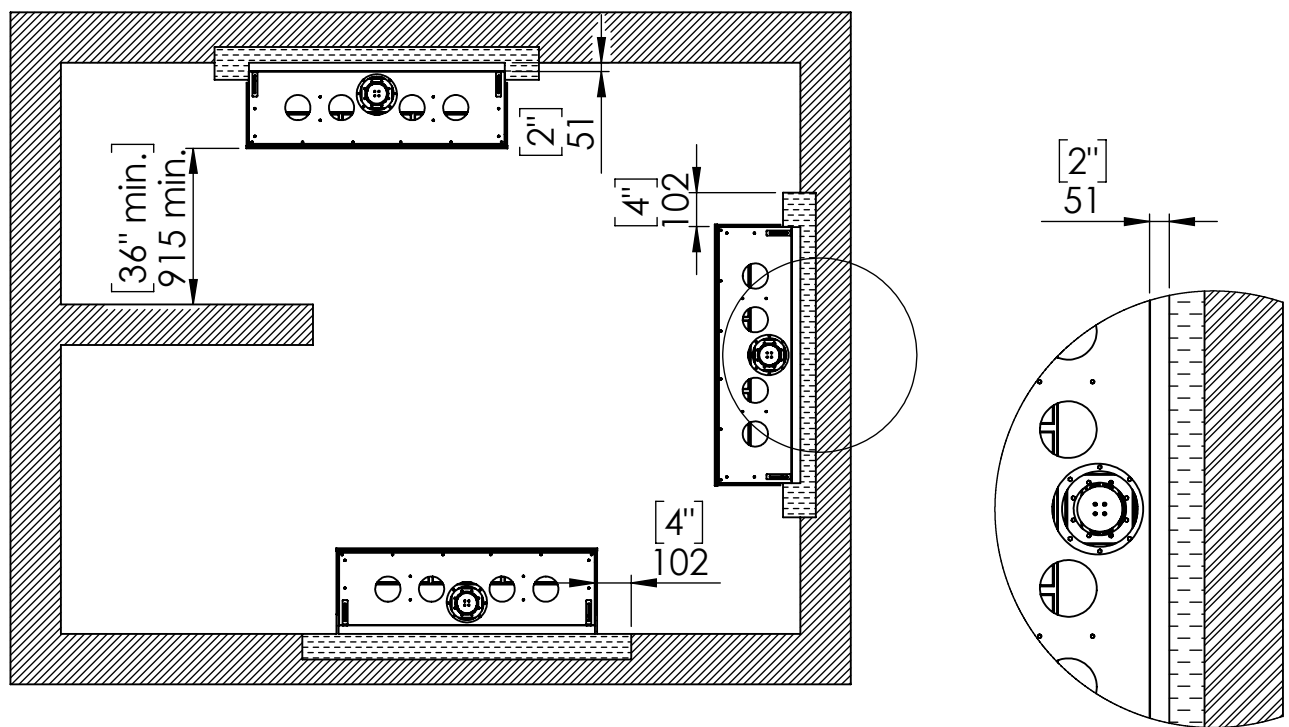

Specifications for Appliance Flare Double Corner 70H

Factor	NG	LPG
Burner Type	35,80,35	35,80,35
Orifice	500,1000,500	160,180,160
BTU Max.	52200	43000
BTU min.	28000	20000
Kw/h	15.3k	12.6k
Chimney DIA.	5X8	5X8
Manifold Pressure[w.c]	3.6	8.8
Efficiency rate	82	79
Glass Size Length\Width	1770.5 X 620 mm	69" 11/16 X 24" 7/16'
Appliance Weigh	200Kg	440lb

Appliance Location



 Combustible Materials
 Non Combustible Materials



FLARE Double Corner 70H

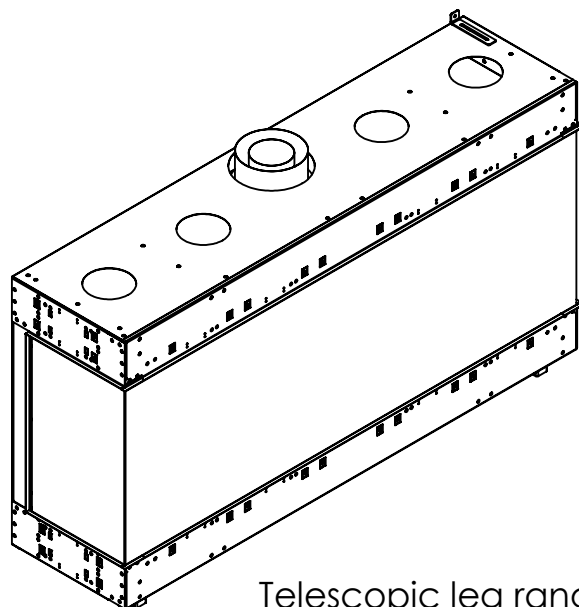
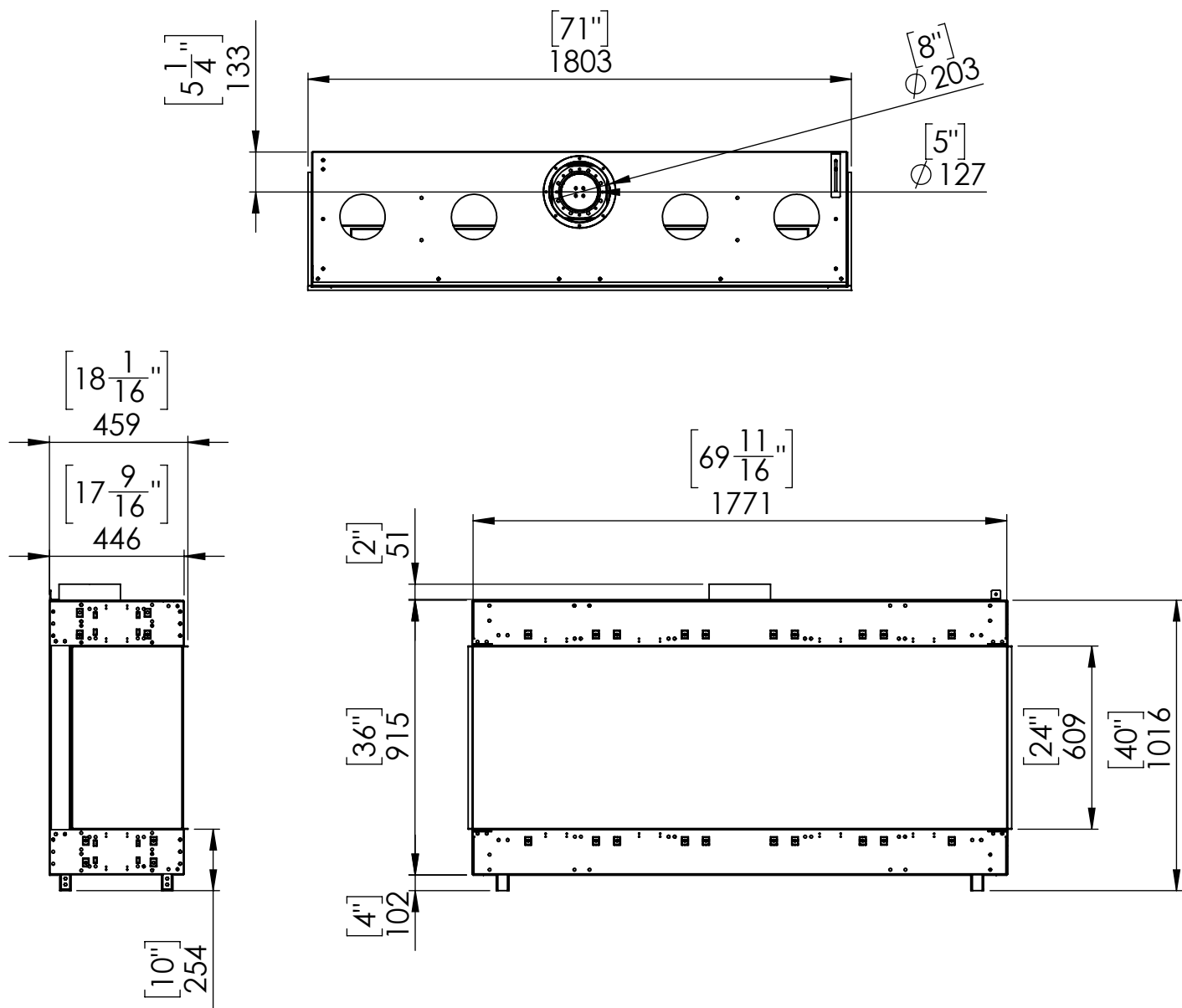

Telescopic leg ranges
(from bottom of glass): 10"-19"

Flat Installation

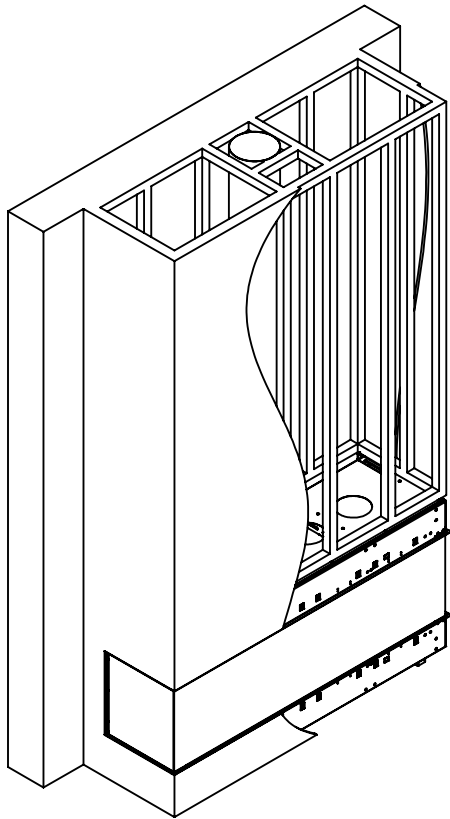

Step 1 - Basic Framing :

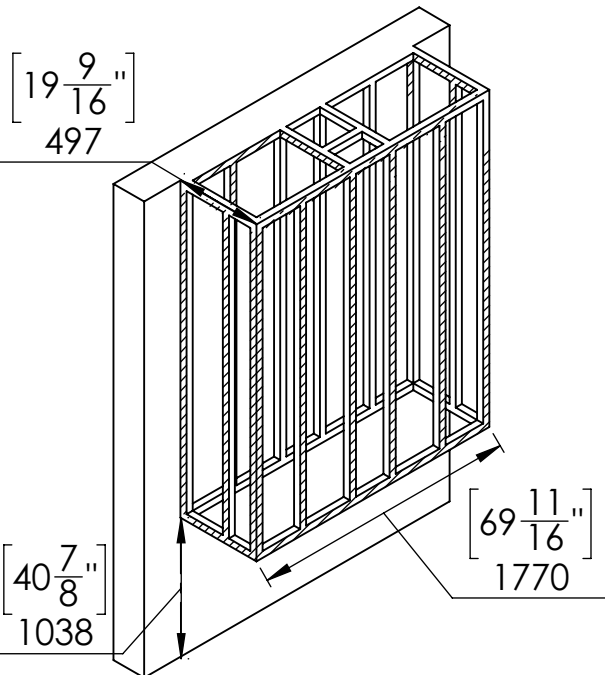

 Steel stud

Recess Installation

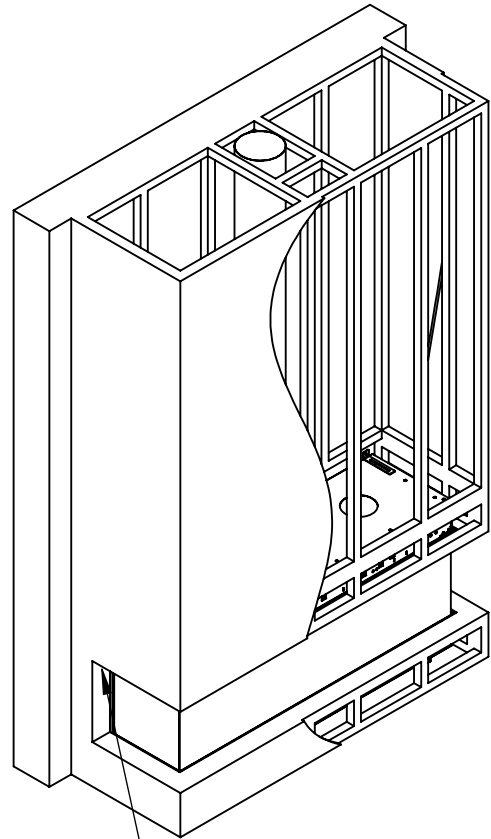

Top of Recess
4" max

Step 1 - Basic Framing :

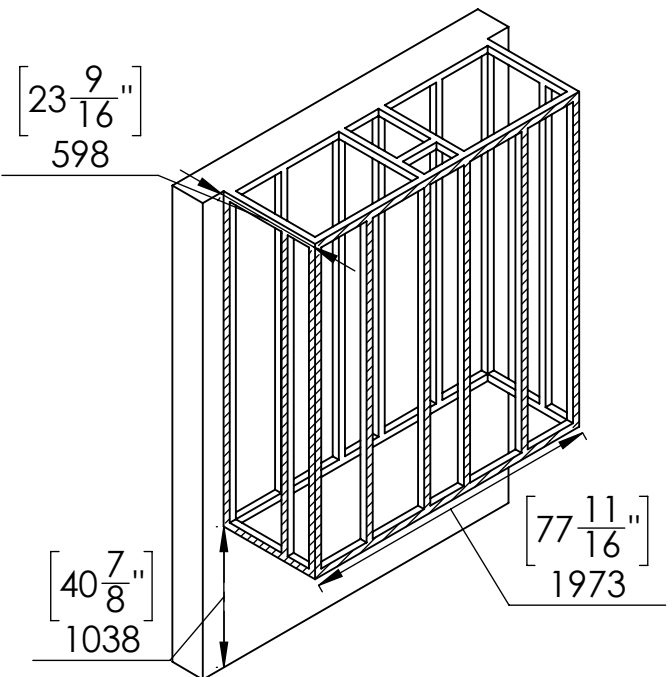

 Steel stud

Flat Installation

Step 2 -Positioning the Fireplace:

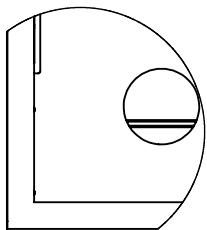
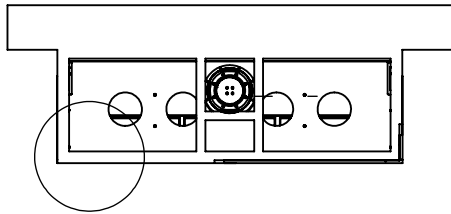

Fireplace frame finishing holder space to match wall finishing thickness

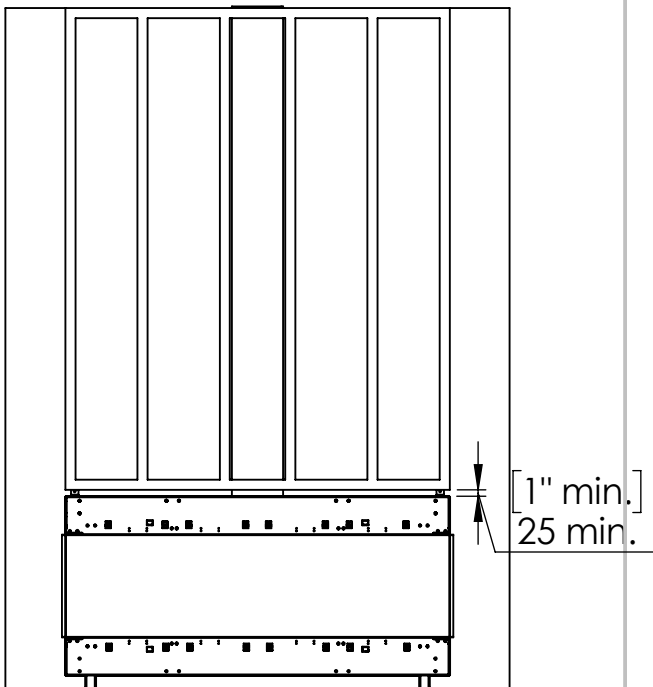

Recess Installation

Step 2 -Positioning the Fireplace:

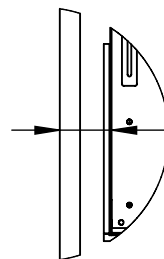
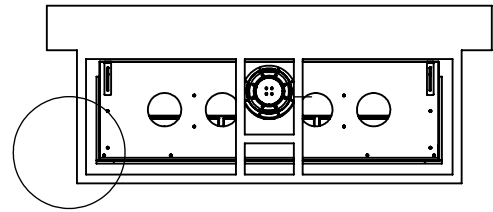

[4" max.]
102 max.

gap to match the max. length of top shelf.

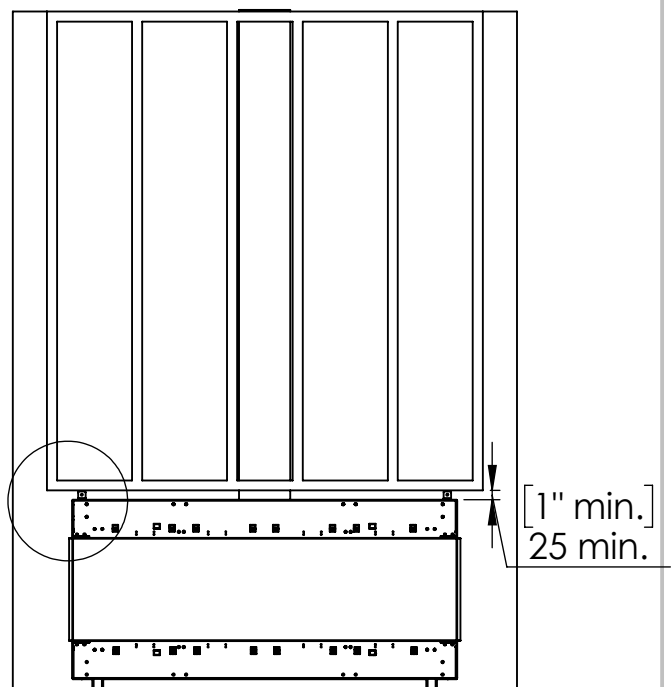

[4" max.]
102 max.

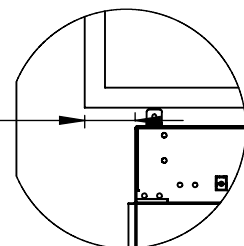

Flat Installation

Last Step - Finishing The Fireplace Wall:

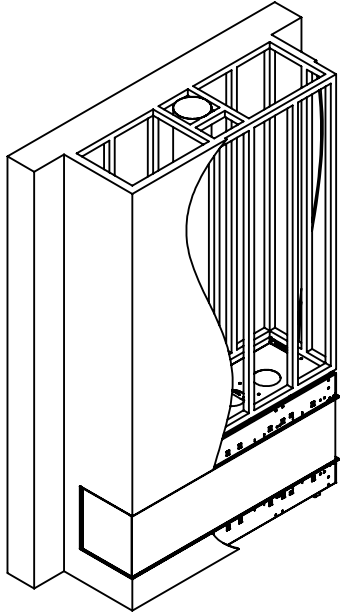

Recess Installation

Step 3 - Framing Front Studs For Recess
After positioning the Fireplace:

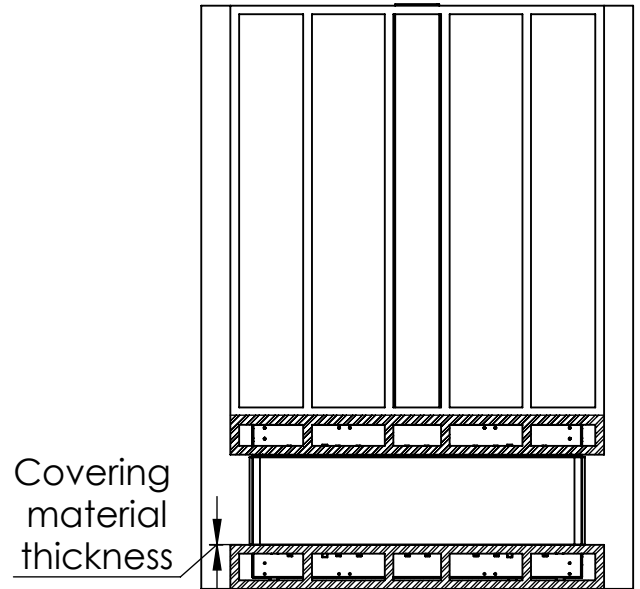

Last Step - Finishing The Fireplace Wall:

