

Chimney Installation

Horizontal Termination

For 5 x 8 vent size create 10" x 12" vent termination opening

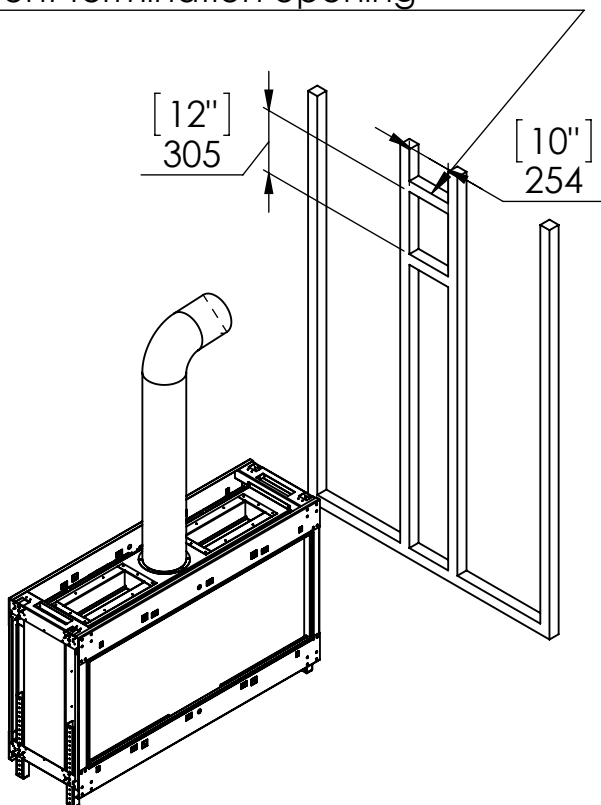

Vertical Termination

For 5 x 8 vent size create 10" x 10" vent termination opening

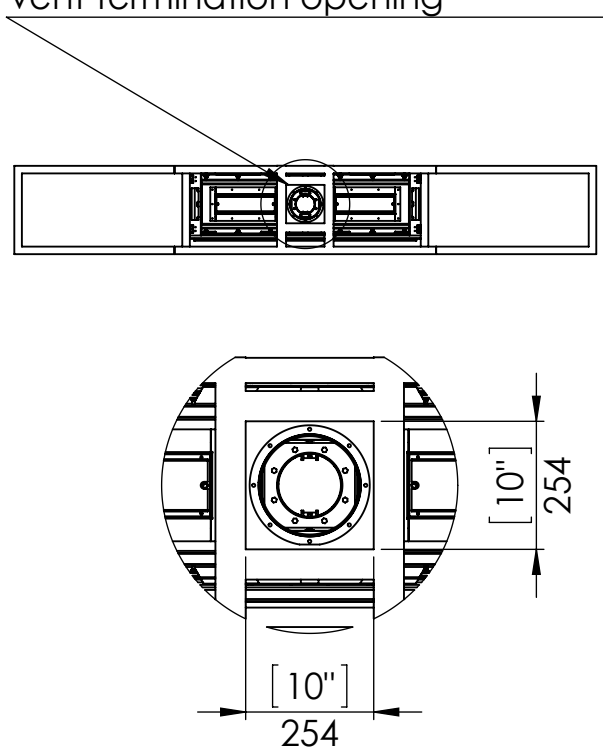

Flat Installation

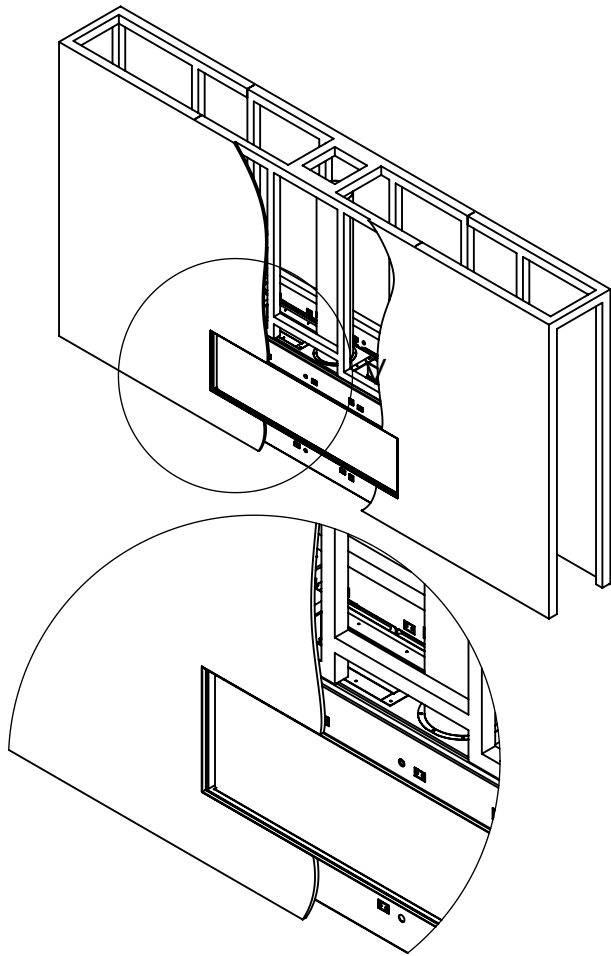

L Shape Installation

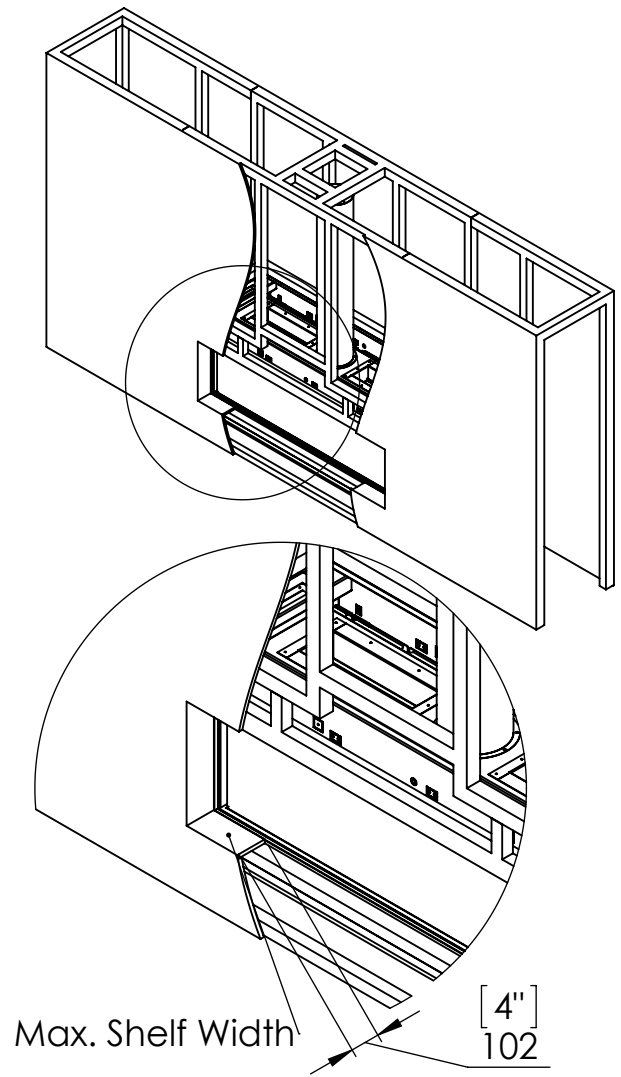

Step 1 - Basic Framing :

Step 1 - Basic Framing :

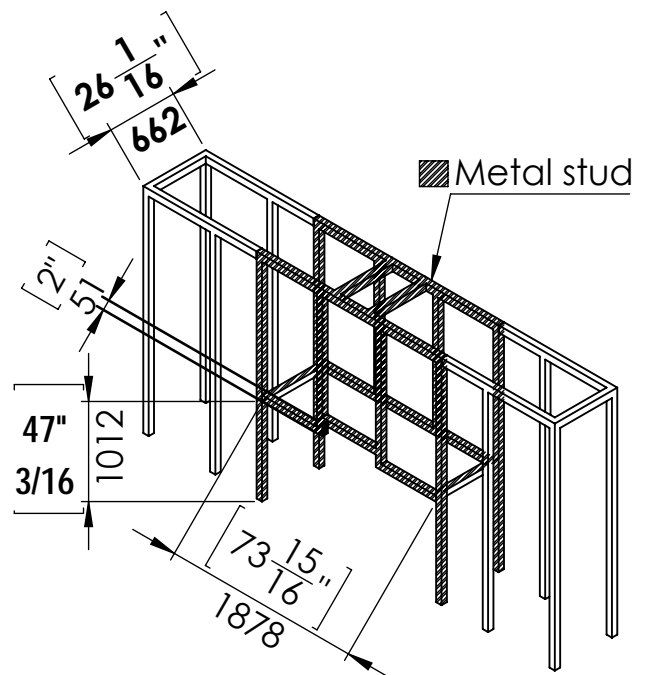
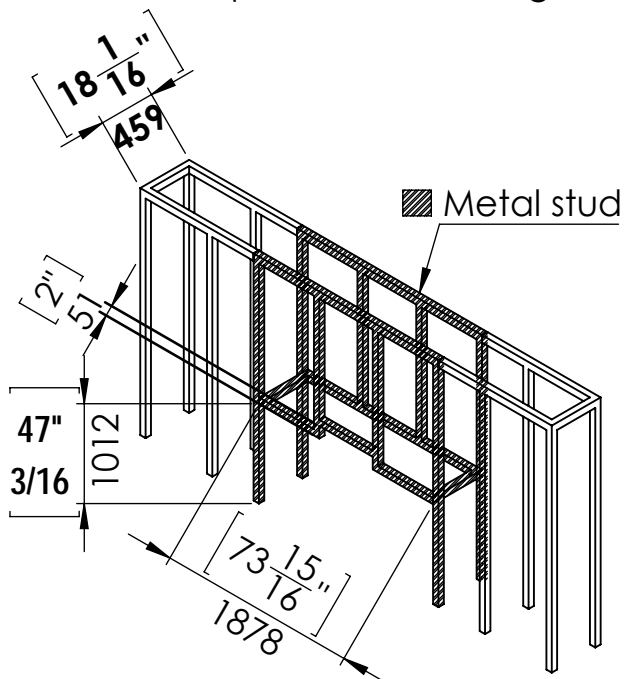

Flat Installation

Step 2 -Positioning the Fireplace:

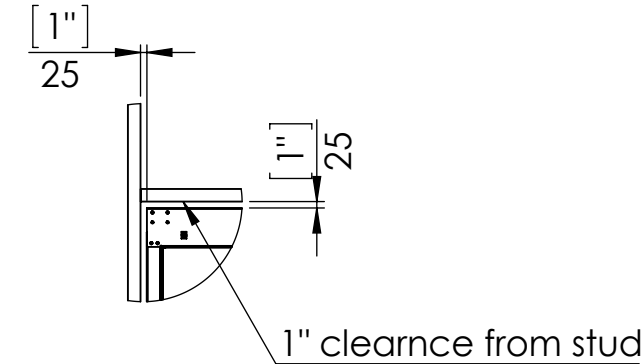
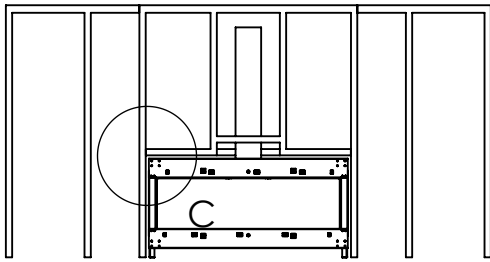
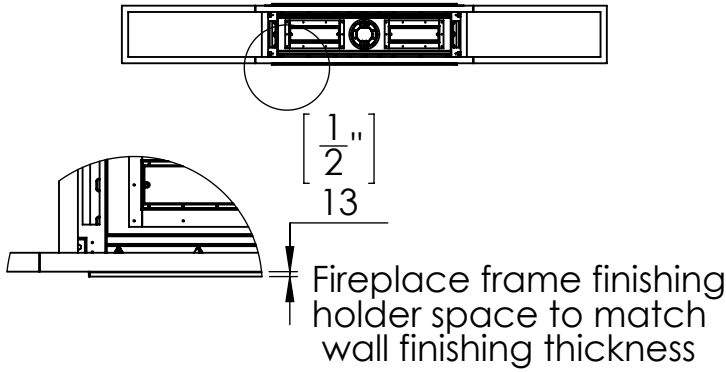

Last Step - Finishing The Fireplace Wall:

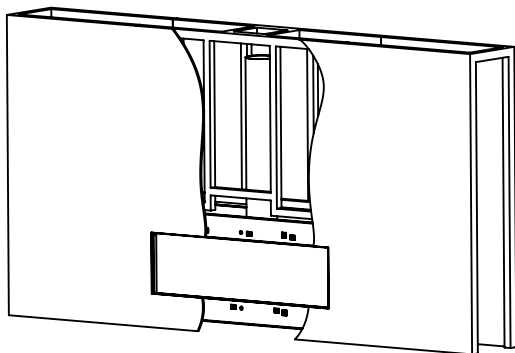

L Shape Installation

Step 2 -Positioning the Fireplace:

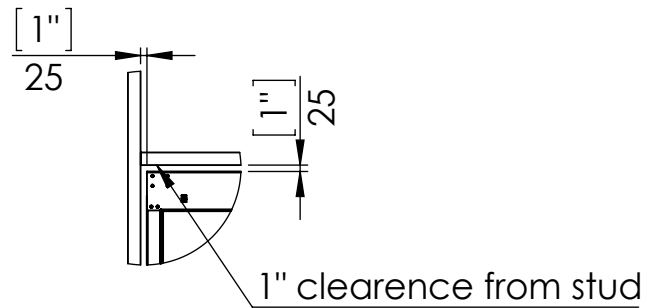
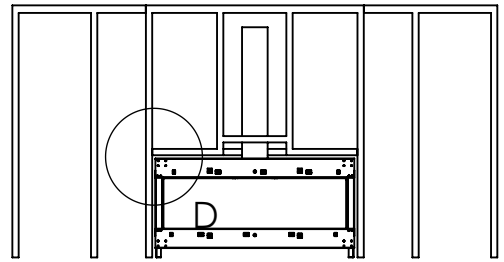
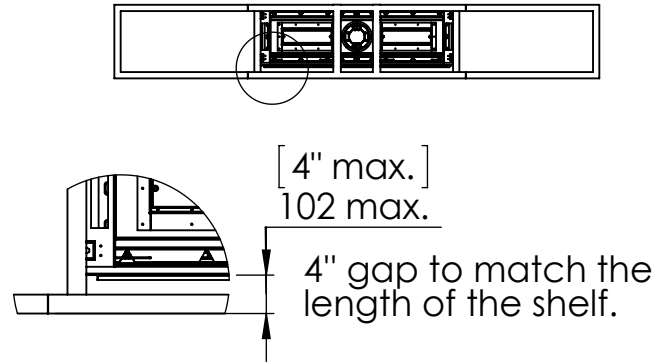

Step 3 - Framing Front Studs For L Shape:

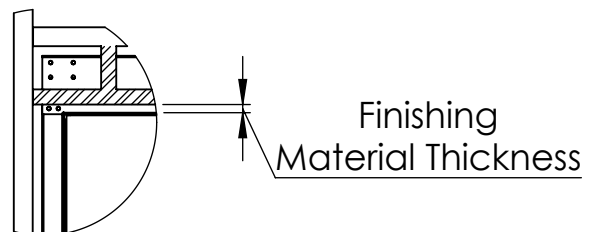
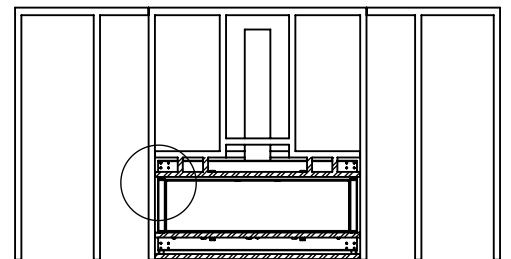

L Shape Finishing Install

Last Step - Finishing The Fireplace Wall:

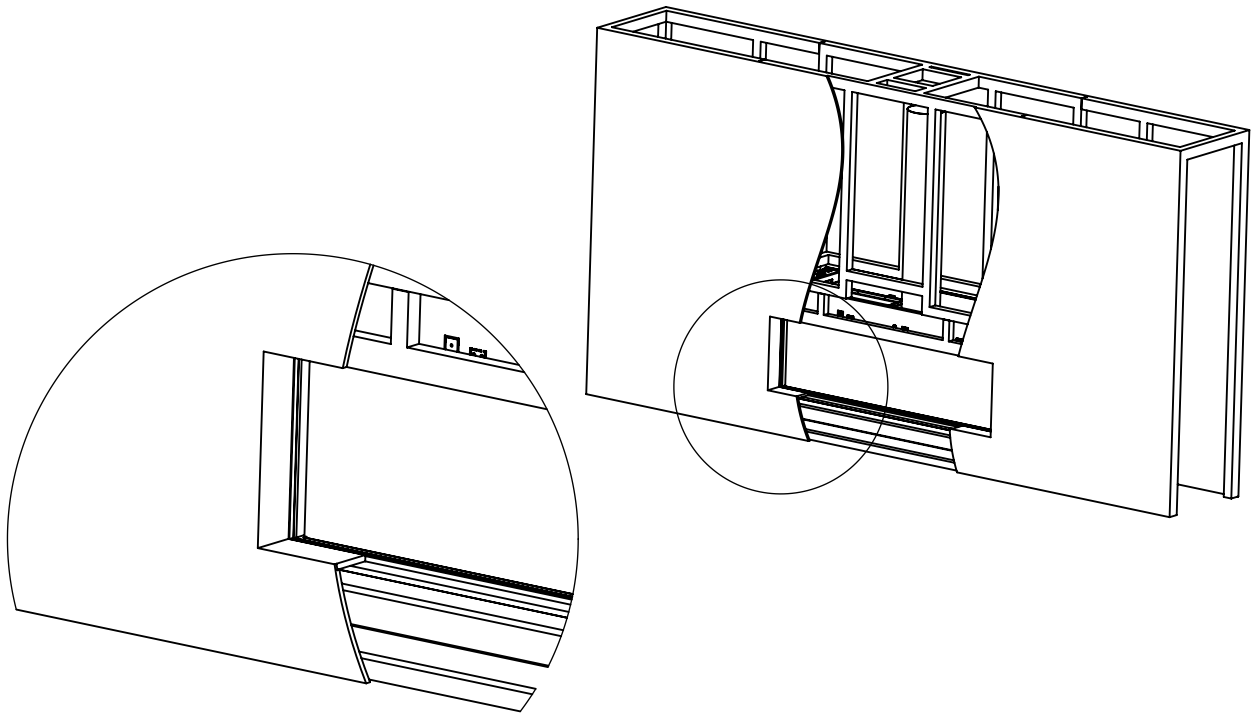

Specifications for Appliance

FLARE SEE THROUGH 70 EH

Factor	NG	LPG
Burner Type	35,80,35	35,80,35
Orifice	550,800,550	160,180,160
BTU Max.	52200	43000
BTU min.	28000	20000
Kw/h	15.3k	12.6k
Chimney DIA.	5X8	5X8
Manifold Pressure[w.c]	3.4	8.8
Efficiency rate	82	79
Glass Size Length\Width	1700 X 767 mm	66" 5/19 X 30" 3/16
Appliance Weigh	233 kg	513 lb