

FLARE See Through 50H

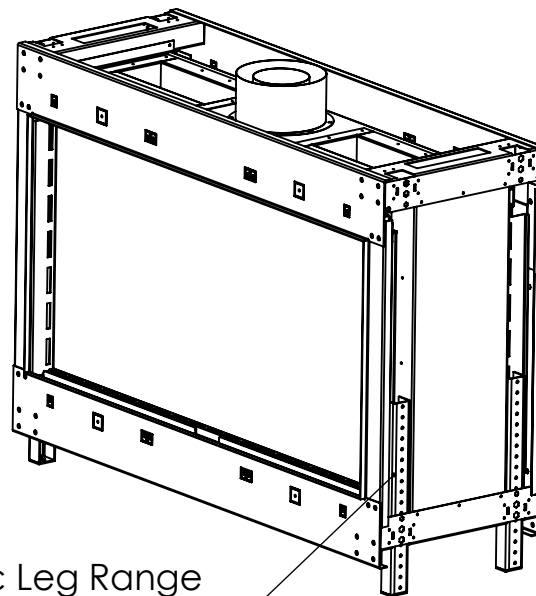

Telescopic Leg Range
(from bottom of glass):
 $9'' - 19''$

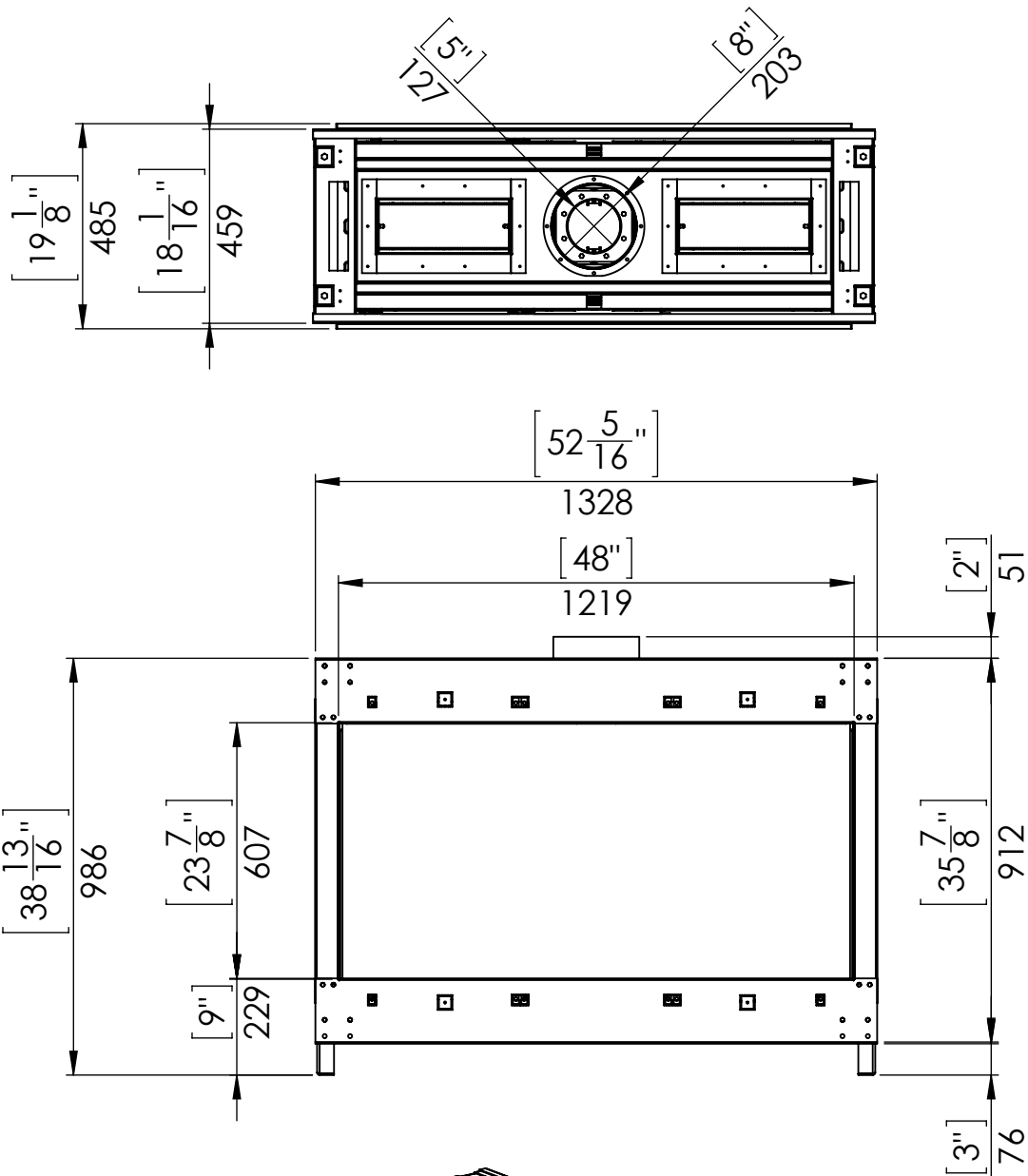
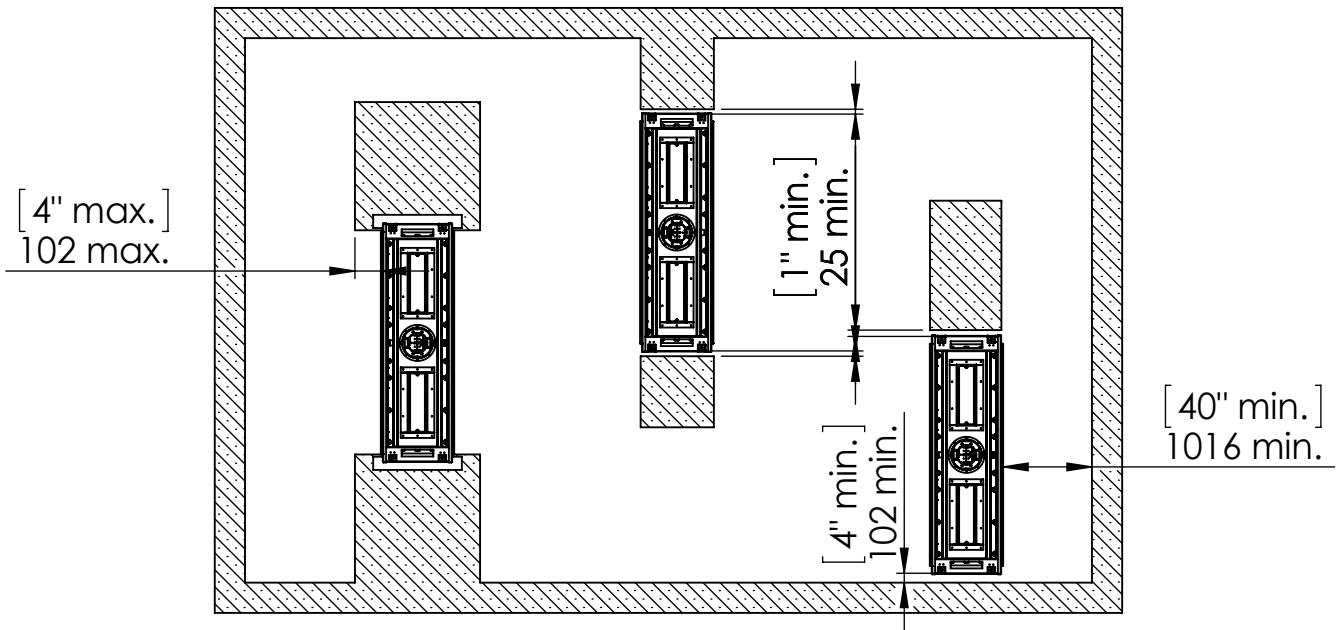

Chimney Installation

Horizontal Termination

For 5 x 8 vent size create 10" x 12" vent termination opening

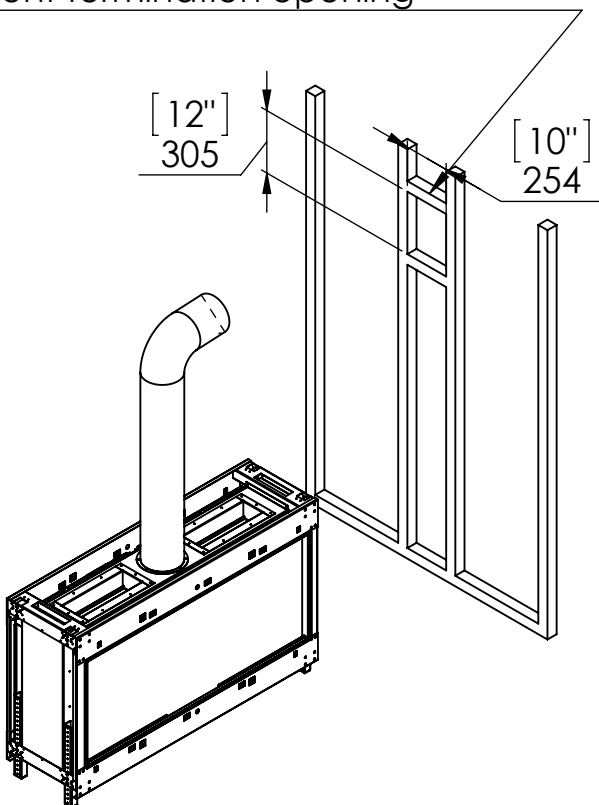

Vertical Termination

For 5 x 8 vent size create 10" x 10" vent termination opening

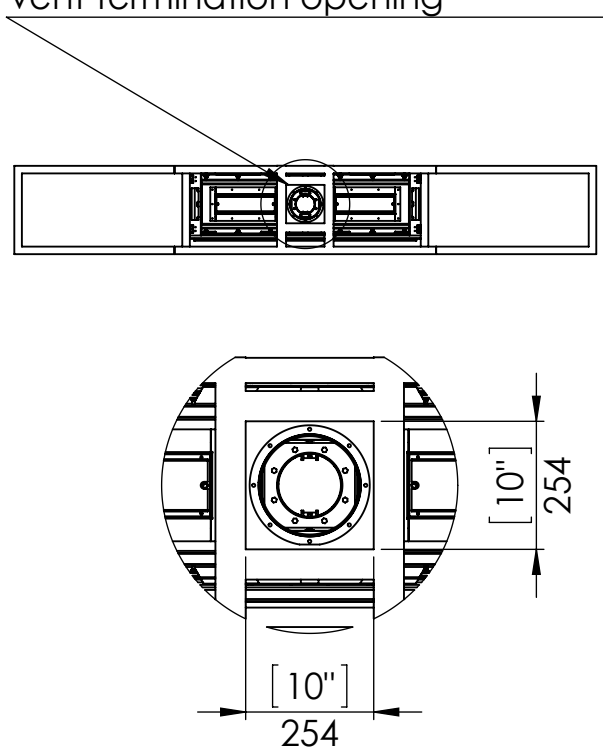

Flat Installation

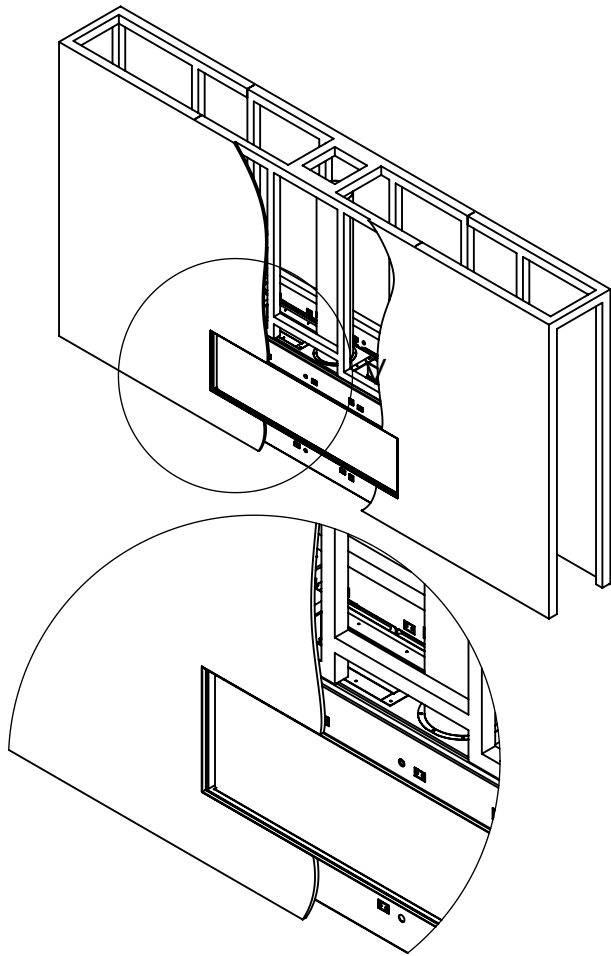

L Shape Installation

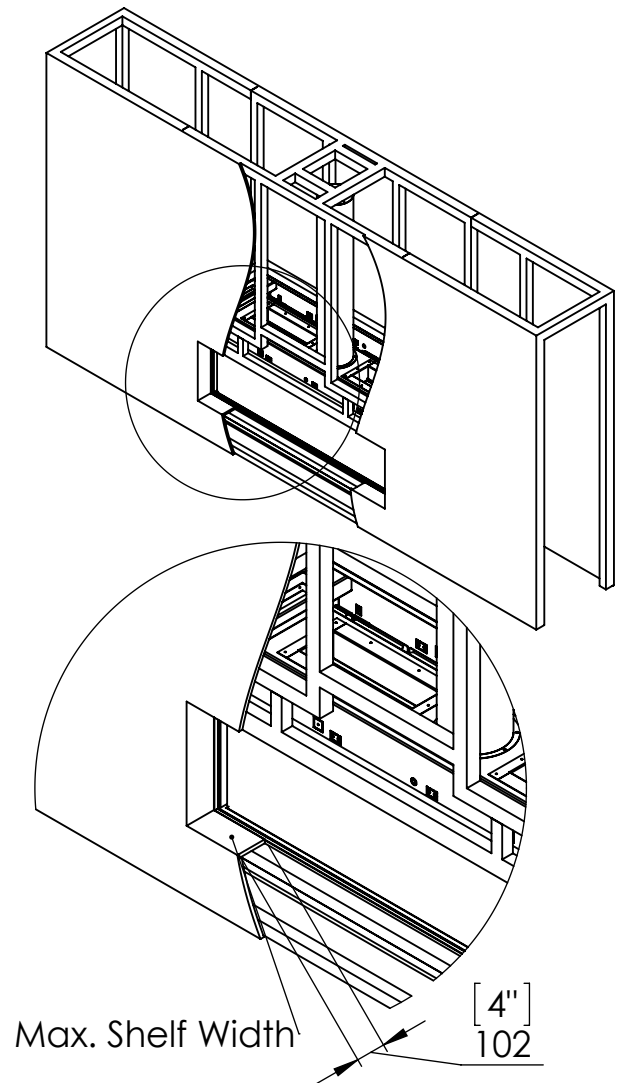

Step 1 - Basic Framing :

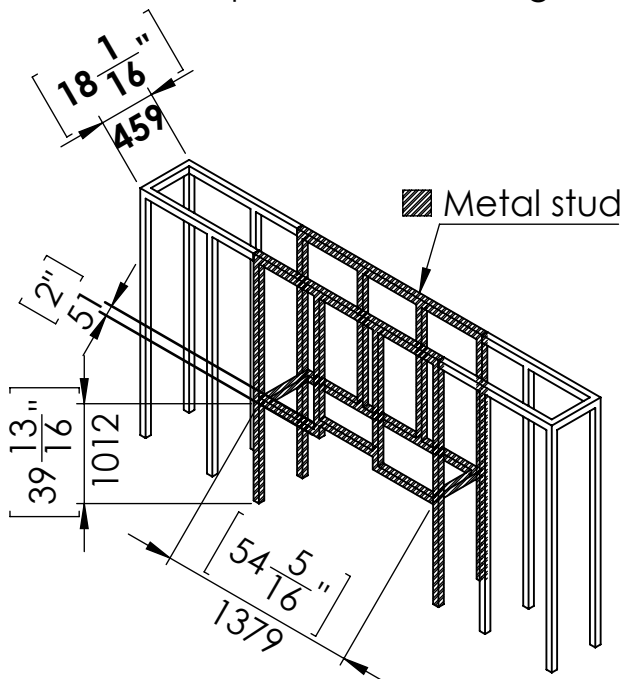

Step 1 - Basic Framing :

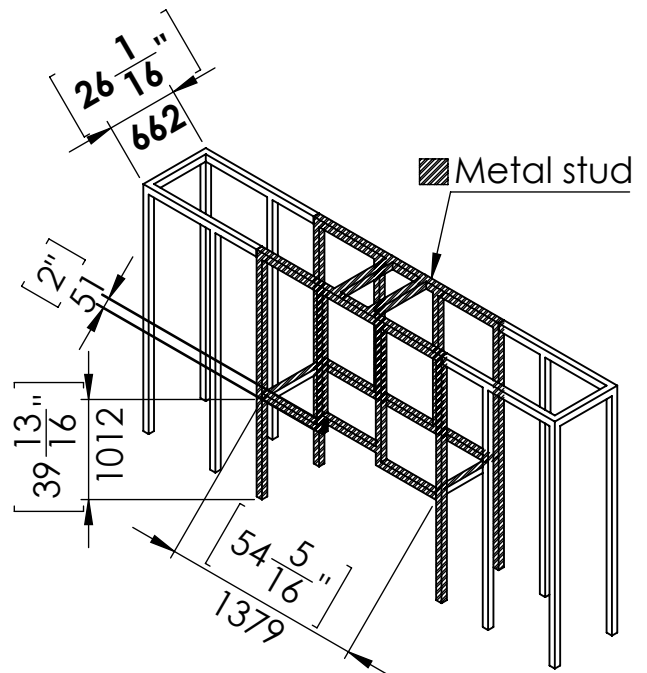

Flat Installation

Step 2 -Positioning the Fireplace:

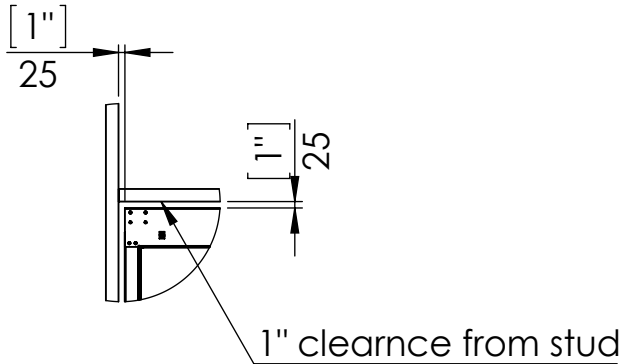
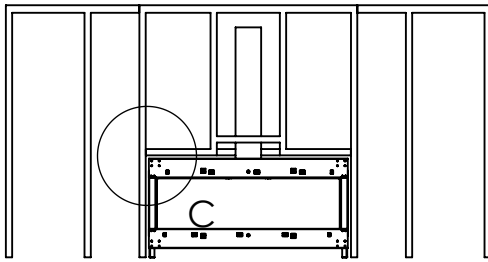
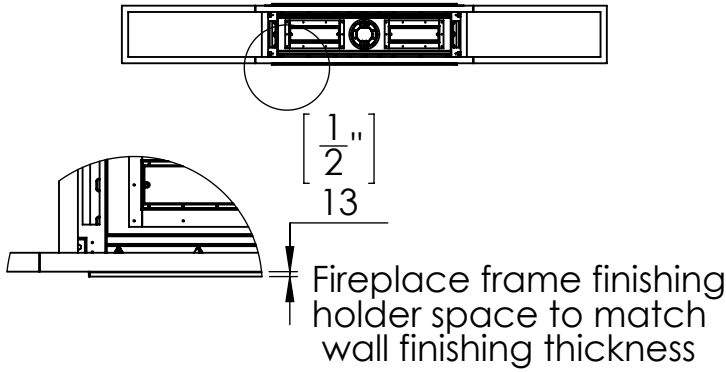

Last Step - Finishing The Fireplace Wall:

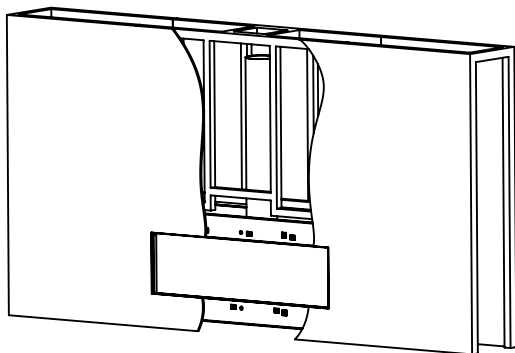

L Shape Installation

Step 2 -Positioning the Fireplace:

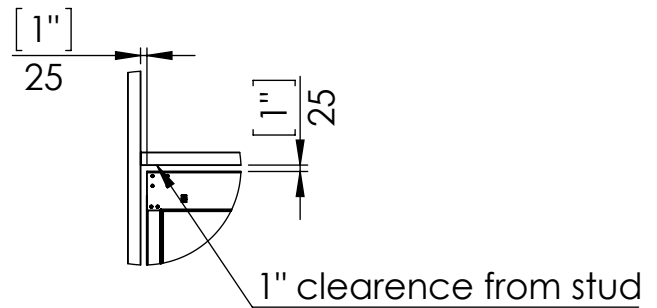
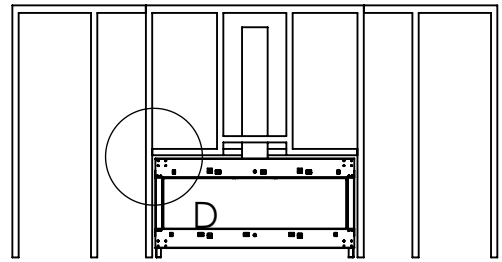
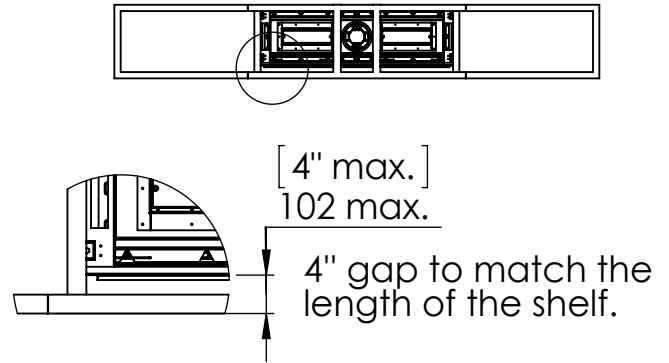

Step 3 - Framing Front Studs For L Shape:

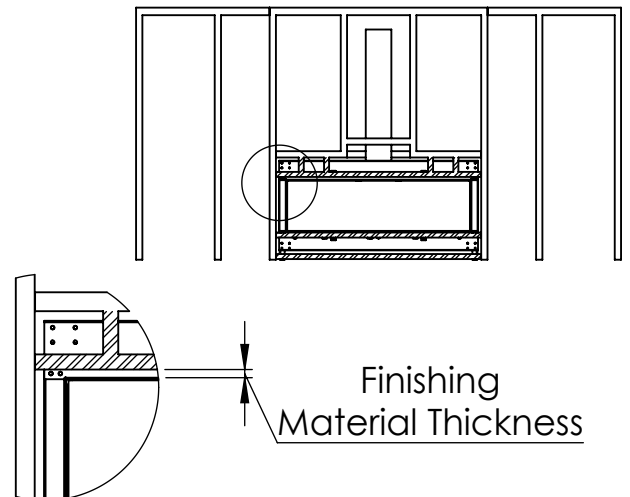

L Shape Finishing Install

Last Step - Finishing The Fireplace Wall:

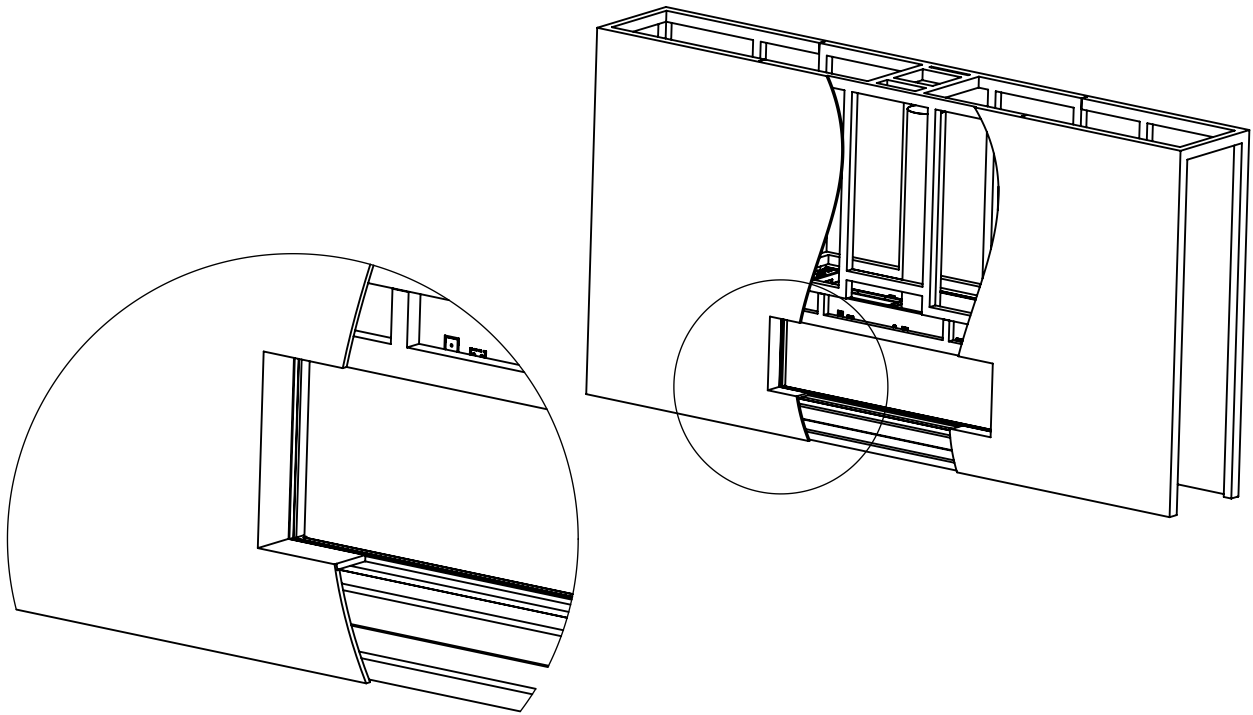

Specifications for Appliance Flare See Through 50H

Factor	NG	LPG
Burner Type	105	105
Orifice	1200	320
BTU Max.	47000	35000
BTU min.	22750	18500
Kw/h	13.8k	10.2k
Chimney DIA.	5X8	5X8
Manifold Pressure[w.c]	4.9	10.4
Efficiency rate	78	82
Glass Size Length\Width	1200 X 620 mm	47" 4/16 X 24" 9/16'
Appliance Weigh	120Kg	264lb