

# FLARE See Through 50

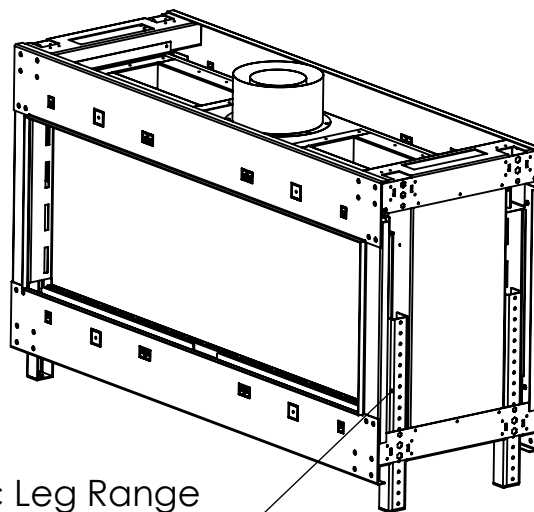

Telescopic Leg Range  
(from bottom of glass):  
9" - 19"

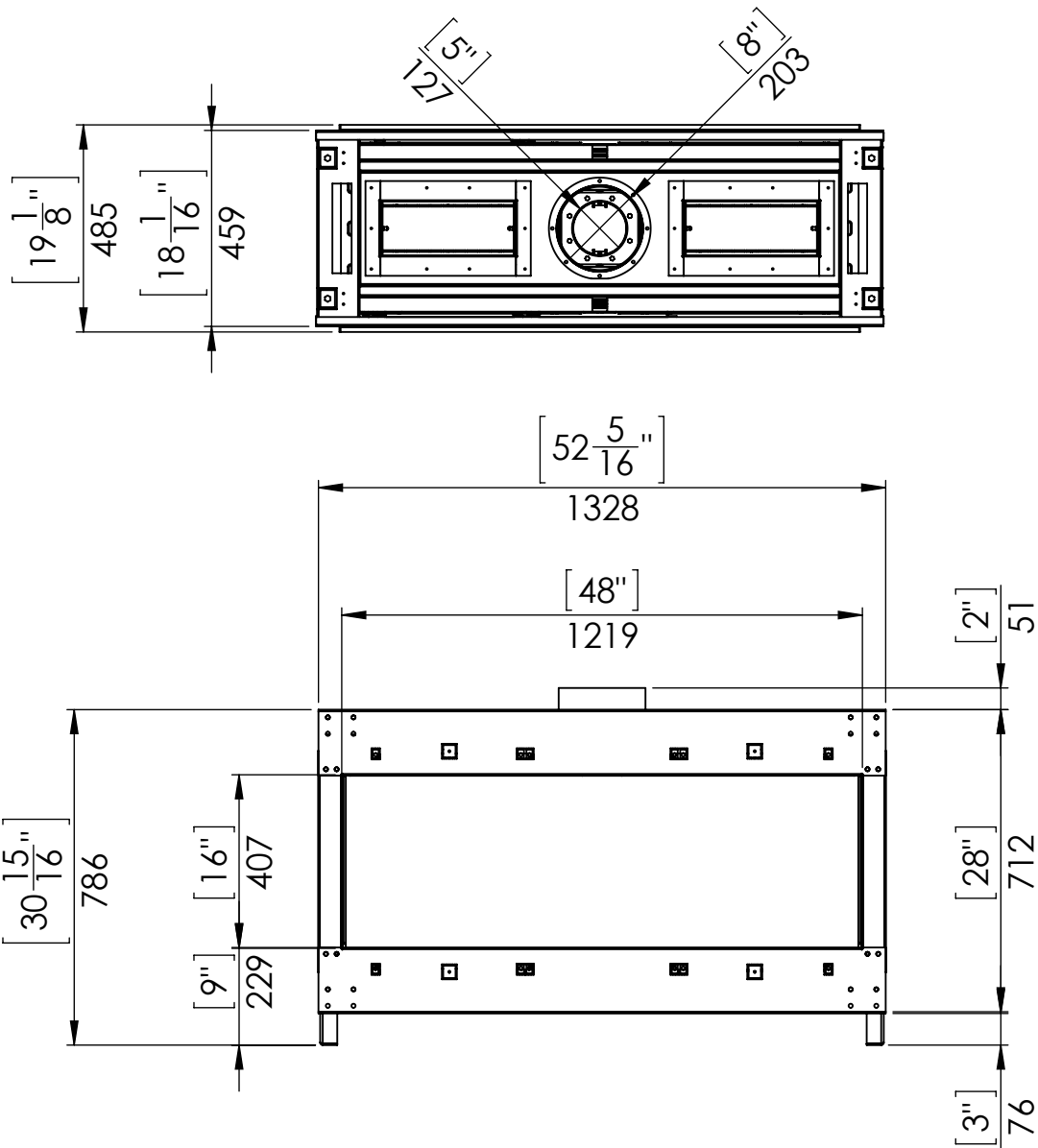
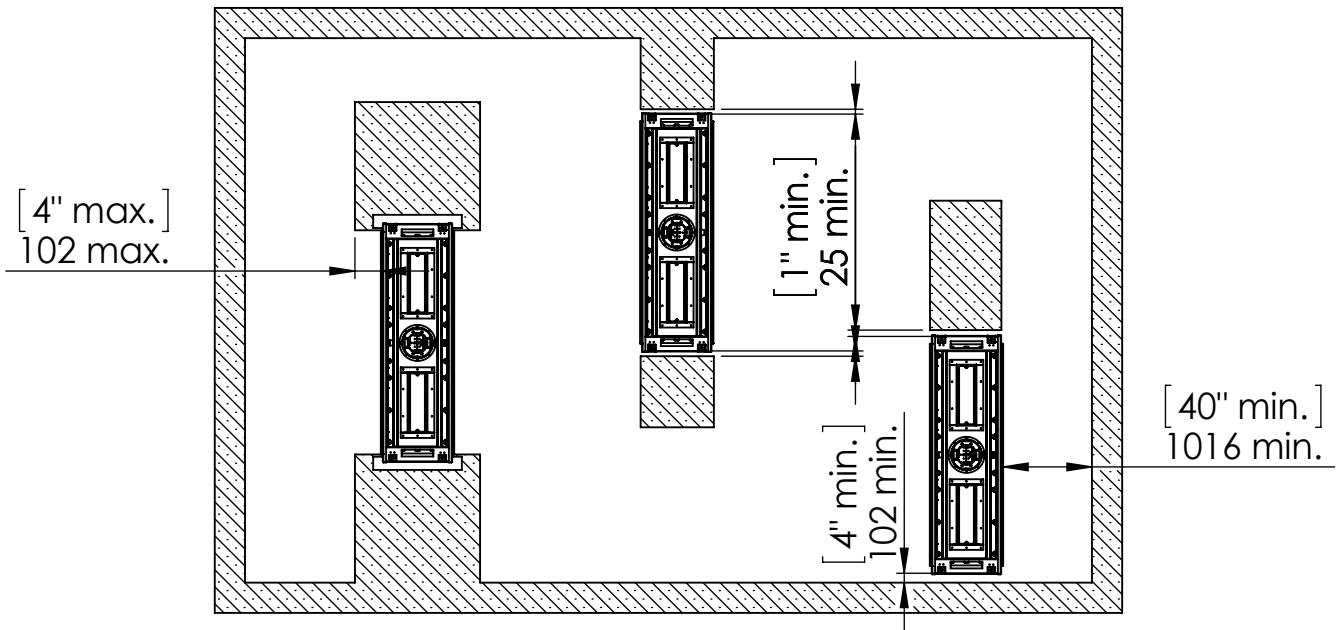

## Chimney Installation

### Horizontal Termination

For 5 x 8 vent size create 10" x 12" vent termination opening

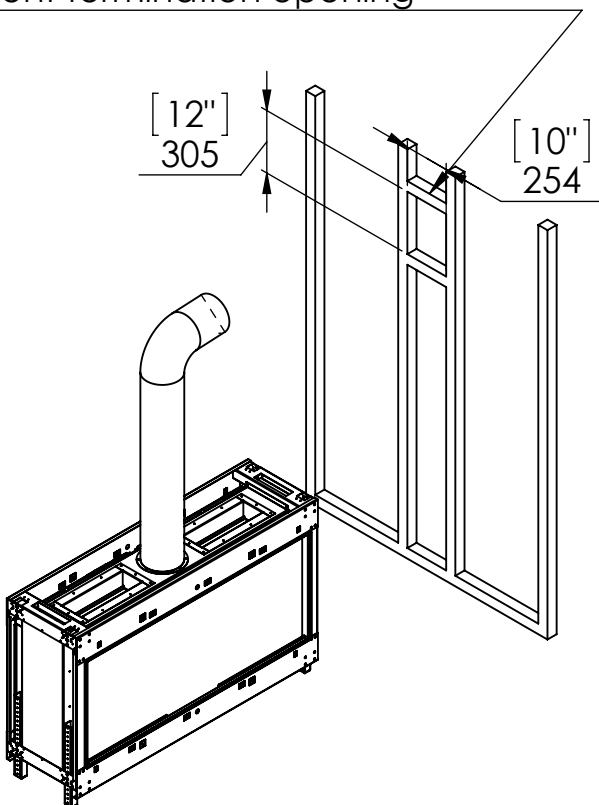

### Vertical Termination

For 5 x 8 vent size create 10" x 10" vent termination opening

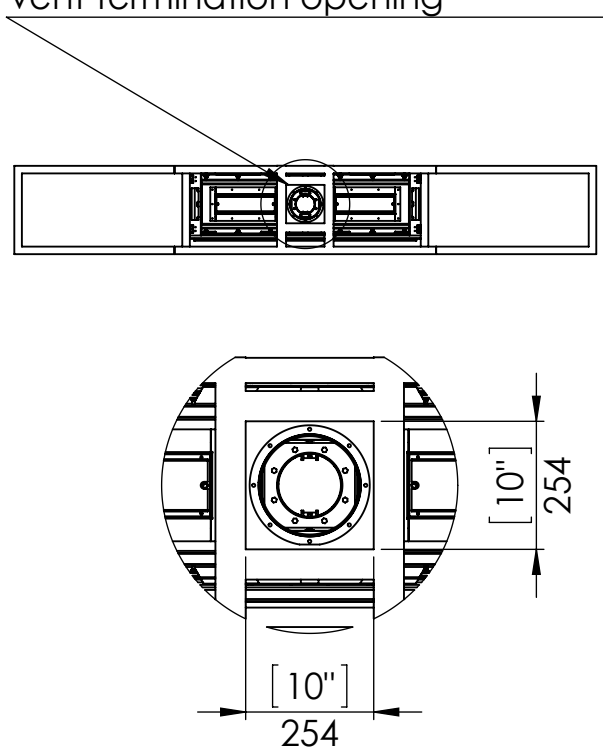

## Flat Installation

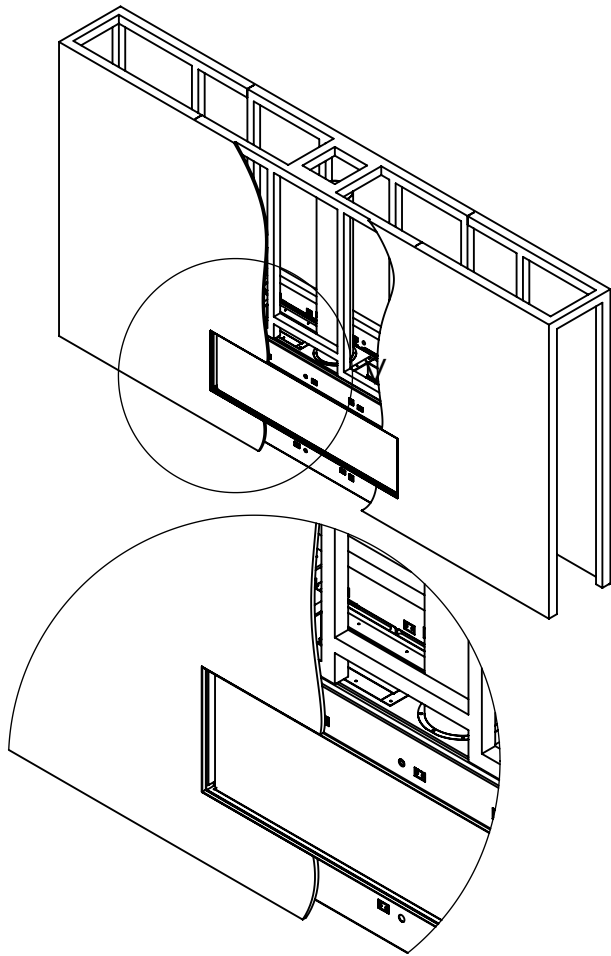

## L Shape Installation

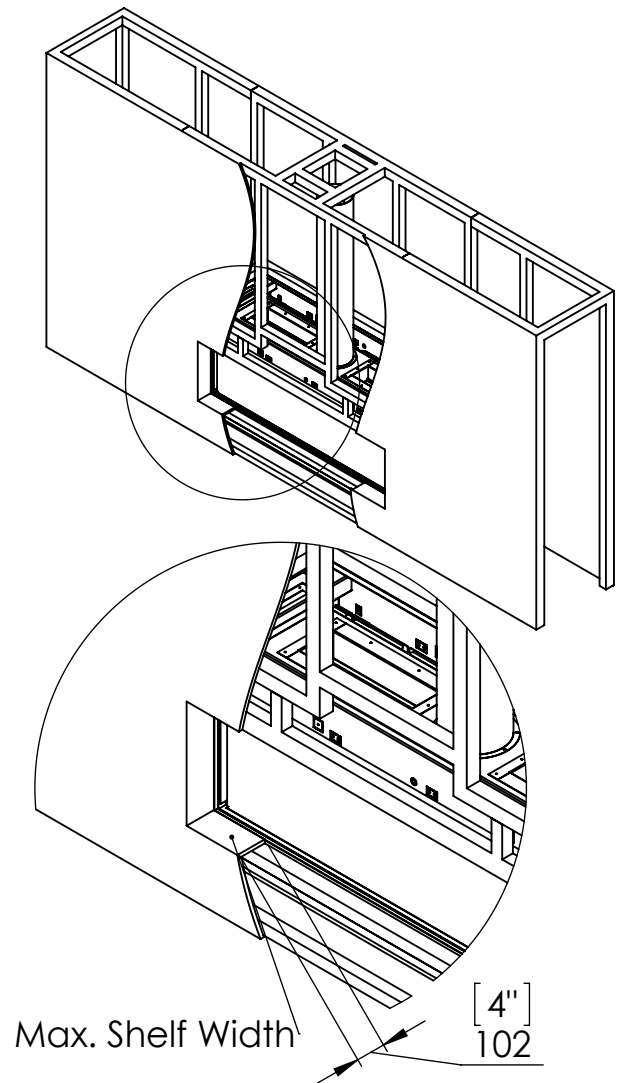

### Step 1 - Basic Framing :

### Step 1 - Basic Framing :

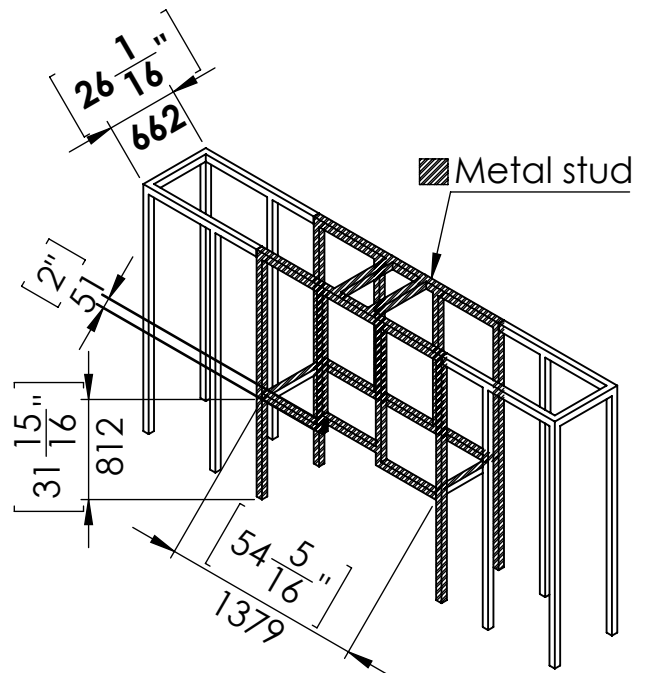
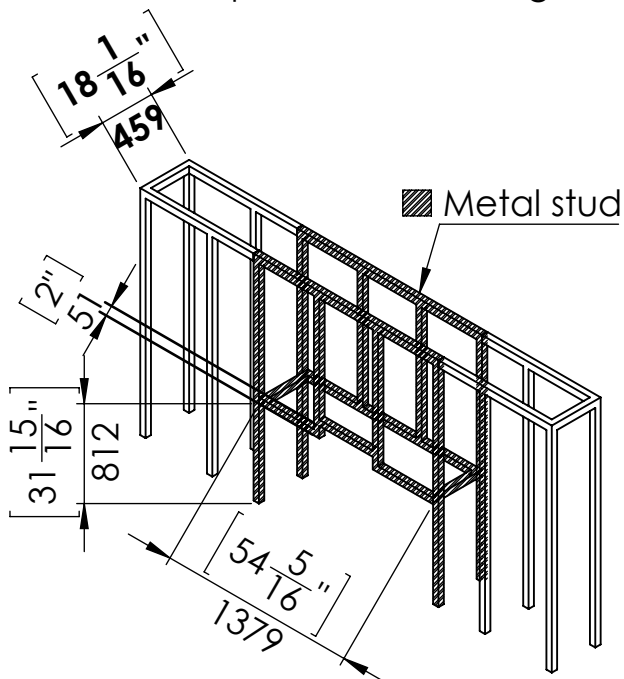

## Flat Installation

Step 2 -Positioning the Fireplace:

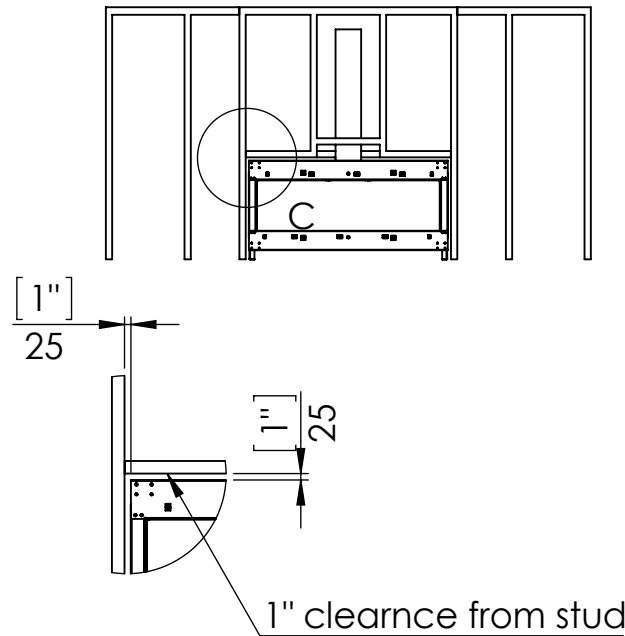
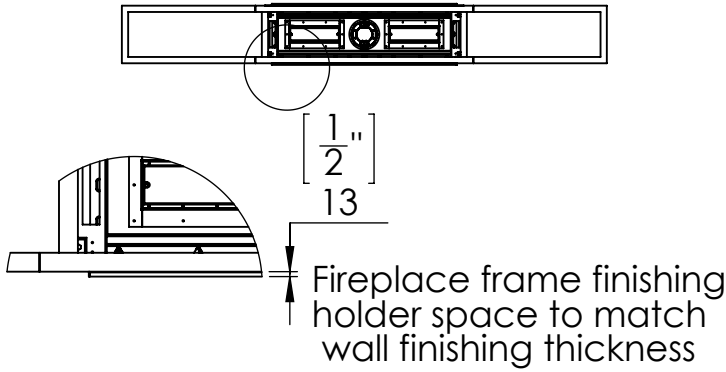

Last Step - Finishing The Fireplace Wall:

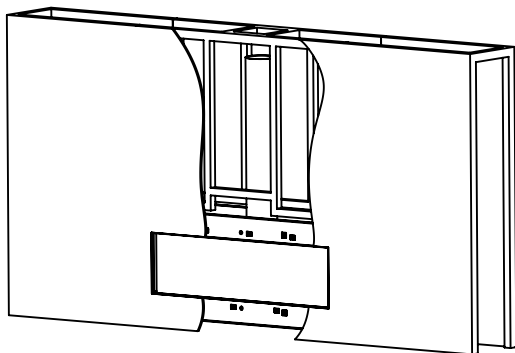

## L Shape Installation

Step 2 -Positioning the Fireplace:

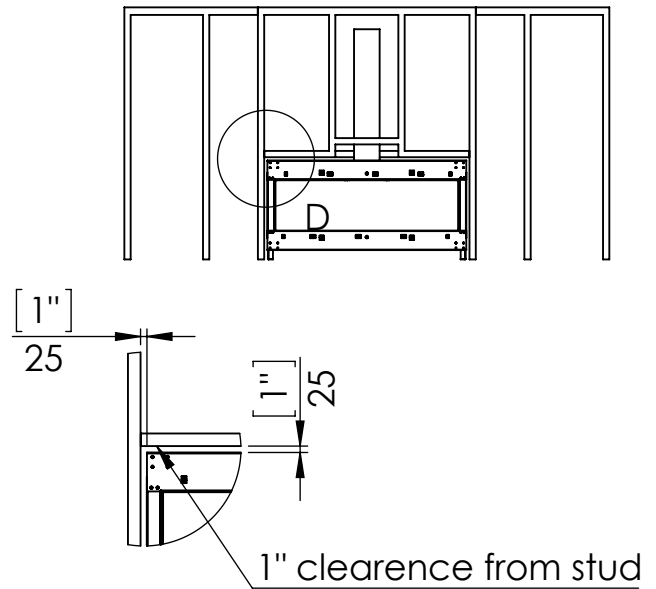
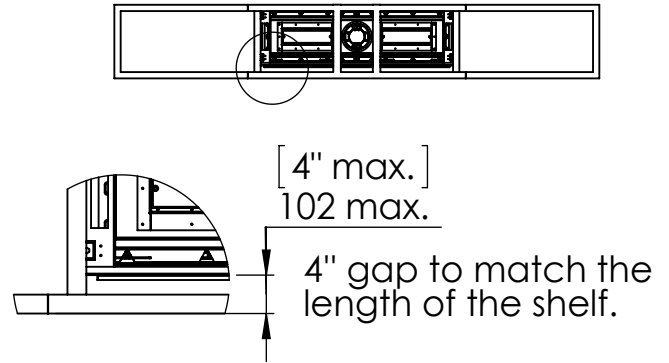

Step 3 - Framing Front Studs For L Shape:

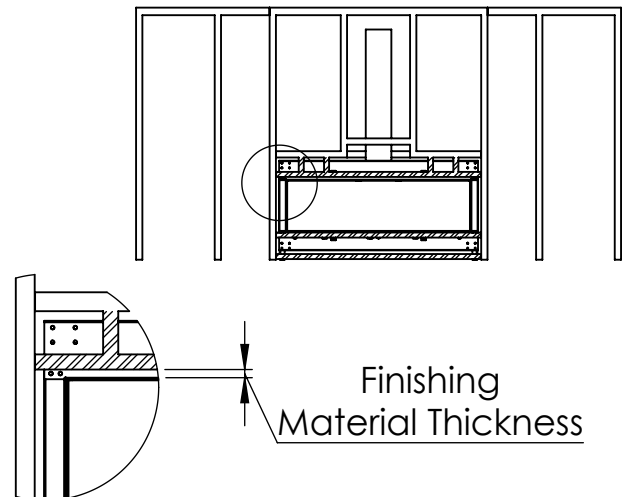

## L Shape Finishing Install

Last Step - Finishing The Fireplace Wall:

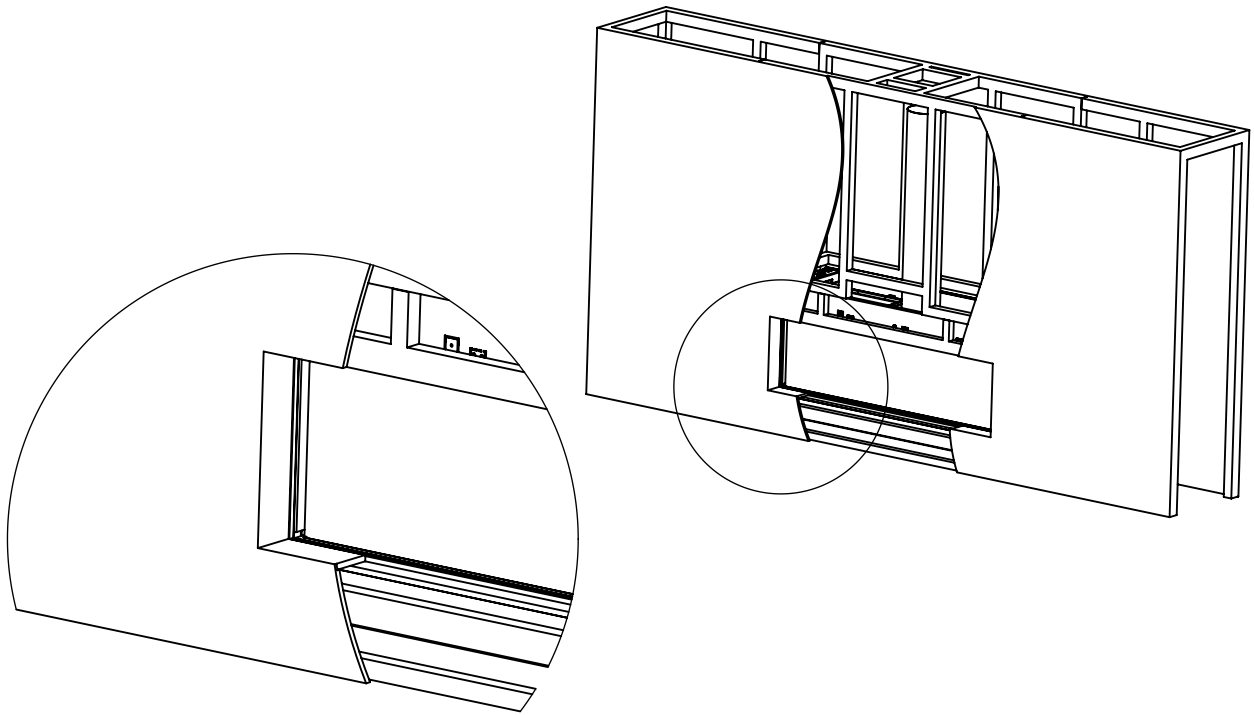

## Specifications for Appliance Flare See Through 50

Factor	NG	LPG
Burner Type	105	105
Orifice	1200	380
BTU Max.	47000	35100
BTU min.	22750	18500
Kw/h	13.8k	10.2k
Chimney DIA.	5X8	5X8
Manifold Pressure[w.c]	4.9	10.4
Efficiency rate	78	82
Glass Size Length\Width	1200 X 420 mm	47" 4/16 X 16" 9/16'
Appliance Weigh	120Kg	265lb